

MARK^{III+} Electric Fire Pump Controller

Project Information



DRAWINGS INCLUDED IN THIS PACKAGE ARE FOR STANDARD CONTROLLERS. ACTUAL "AS BUILT" DRAWINGS MAY DIFFER FROM THOSE SHOWN HERE.

Firetrol, Inc.

3362 Apex Peakway
Apex, North Carolina 27502
P +1 919 460 5200
F +1 919 460 5250
www.firetrol.com

While every precaution has been taken to ensure accuracy and completeness herein, Firetrol, Inc. assumes no responsibility, and disclaims all liability, for damages resulting from use of this information or for any errors or omissions. Specifications and drawings are subject to change without notice.
©2024 Firetrol, Inc. All Rights Reserved.

Firetrol MARK^{III+} Electric Fire Pump Controller

Specifications

1.0 Main Fire Pump Controller

The main fire pump controller shall be a factory assembled, wired and tested unit. The controller shall be of the combined manual and automatic type designed for full voltage starting of the fire pump motor having the horsepower, voltage, phase and frequency rating shown on the plans and drawings. The controller shall be rated for an Ambient Temperature Operating Range of 39°F (4°C) to 104°F (40°C).

1.1 Starting Configuration

The controller shall be designed to use Model and Configuration:

FTA1000 - Full Voltage starting intended for use with electric motor driven fire pumps where the capacity of the power source permits full voltage starting. Full voltage is applied to the motor as soon as the controller is actuated. Full voltage starting is simple and low cost and is preferred whenever the utility or emergency generator set will permit this type of starting.

FTA1250 Part Winding Starting, used where the characteristics of the power source do not permit full voltage starting. When the controller is actuated via pressure, START push-button, deluge valve contact, etc., the first contactor closes, connecting one of the motor windings to the line. During starting, the motor will draw approximately 65% of its normal locked rotor current and develop approximately 42% of its normal starting torque. After a time delay, the second contactor closes, connecting the second winding in parallel with the first. The motor then draws its normal running current and develops its rated torque.

FTA1300 Wye-Delta, Open Transition Starting, used with delta-wound squirrel cage motors. FTA1300 controllers are of the open circuit transition type in which the motor circuit is opened during the transition from start to run. Actuating the controller by the pressure switch, START push-button or deluge valve contact closes the start contactor connecting the motor to the line in the wye connection. The motor will draw approximately 33% of its normal inrush current and develop approximately 33% of its normal starting torque. After a time delay, the motor is automatically reconnected in delta, applying full voltage to the motor windings. These controllers are recommended especially for use with generator sets.

FTA1350 Wye-Delta, Closed Transition Starting Fire Pump Controllers are used with delta-wound squirrel cage motors. These controllers are of the closed circuit transition type in which the motor circuit remains closed during the transition from start to run. Actuating the controller via pressure, START push-button or deluge valve contact closes the start contactor connecting the motor to the line in the wye connection. The motor will draw approximately 33% of its normal inrush current and develop approximately 33% of its normal starting torque. After a time delay, the motor is automatically reconnected in delta, applying full voltage to the motor windings. During this transition, a resistor is connected to each phase, minimizing line disturbances and voltage drop during starting. These controllers are recommended especially for use with generator sets.

FTA1800 Autotransformer Starting Fire Pump Controllers use an autotransformer to supply reduced voltage when starting the motor. The controller is of the closed circuit type where the motor circuit remains closed during the transition from start to run resulting in minimum line disturbance. The autotransformer has three taps for selection of starting current and torque; 50% tap for 150% current and 25% torque, 65% tap (factory setting) for 250% current and 42% torque and the 80% tap for 384% current and 64% torque.

FTA1930 Solid State Reduced Current Starting Fire Pump Controllers feature soft start, soft stop and system sensing capabilities that not only provide for reduced current starting, but also offer an improved level of hydro mechanical performance.

1.2 Standards, Listings & Approvals

The controller shall conform to all the requirements of the latest editions of: NFPA 20, *Standard for the Installation of Stationary Pumps for Fire Protection* NFPA 70, *National Electrical Code*.

The controller shall be listed by:

Underwriters Laboratories, Inc., in accordance with UL218, *Standard for Fire Pump Controllers* Canadian Standards Association CSA-C22.2, *Standard for Industrial Control Equipment (cUL)*

CE - Low Voltage Directive

The controller shall be approved by:

Factory Mutual (IEC 62091)

The City of New York for fire pump service

1.3 Enclosure

The controller components shall be housed in a NEMA Type 2 (IEC IP22) drip-proof, wall mounted enclosure with bottom entry gland plate and lifting lugs.

1.4 Withstand Ratings (Short Circuit Current Ratings)

All controller components shall be front mounted, wired and front accessible for maintenance. The available short circuit current ratings are shown below.

Code	200-208V 5-150 HP	220-240V 5-200 HP	380-415V 5-350 HP	440-480 5-400 HP	550-600 5-500 HP
M - Standard	100kA	100kA	100kA	100kA	N/A
N - Intermediate	150kA	150kA	150kA	150kA	N/A
P - High	200kA	200kA	200kA	200kA	N/A
Q - Intermediate	N/A	N/A	N/A	N/A	100kA
R - Standard	N/A	N/A	N/A	N/A	50kA
Code	200-208V 200 HP	220-240V 250-400 HP	380-415V 400-500 HP	440-480 450-500 HP	
M - Standard	50A	50kA	50kA	50kA	
N - Intermediate	N/A	N/A	N/A	N/A	
P - High	100kA	100kA	100kA	100kA	
Q - Intermediate	N/A	N/A	N/A	N/A	
R - Standard	N/A	N/A	N/A	N/A	

1.5 Power Components

The controller shall include a combination isolating disconnect switch/circuit breaker, rated for not less than 115% of the motor full load current, mechanically interlocked and operated with a single, externally mounted handle. The isolating disconnect switch/circuit breaker shall be mechanically interlocked so that the

enclosure door cannot be opened with the handle in the ON position except by a hidden tool operated bypass mechanism. The isolating disconnect switch/circuit breaker shall be capable of being padlocked in the OFF position for installation and maintenance safety, and shall also be capable of being locked in the ON position without affecting the tripping characteristics of the circuit breaker.

The controller will include a voltage surge arrestor and Across the Line motor starter. The controller shall be equipped with a single handle, manually operated, emergency start mechanism capable of being latched in the ON position.

1.6 Operator Interface (HMI)

The operator interface shall be a 7.0" capacitive type LCD color touch screen (HMI technology) powered by an embedded microcomputer with software PLC logic. Included shall be keypad type push-buttons for START, STOP and TEST. The screen shall include menus for: *Home · Alarms · Configuration · History · Service · Manuals · Language.*

The HMI shall graphically display the following: *Voltage and Amperage of all 3 phases simultaneously using true RMS Technology · Motor Stopped/Running · Starting Cause · Actuation Mode · Controller Type · Shutdown Mode · Date & Time · Pump Room Temp. · System Pressure*

System pressure shall be capable of being displayed as: *PSI, kPa, Bar, Feet of Head or Meters of Water.*

The HMI shall allow programming and display of: *Cut In & Cut Out Pressure Settings · Minimum Run Timer · Sequential Start Timer · Periodic Test Timer*

The HMI allows the user to select the language of the system and download the manual or view the manual on screen.

1.7 State and Alarm Indication

Visual indication shall be provided for the following:

Power Available • Motor Run • Periodic Test • Manual Start • Deluge Valve Start • Remote Automatic Start • Remote Manual Start • Emergency Start • Pump On Demand/Automatic Start • Pump Room Temperature • Lockout

The digital display shall visually indicate the following alarms:

• Locked Rotor Current • Fail To Start • Under/Over Current • Under/Over Voltage • Phase Unbalance • Check Test Solenoid Valve • Weekly Test Cut-In Not Reached • Transducer Fault • Control Voltage Not Healthy • Motor Trouble • Pump Room Alarm • Invalid Cut-In • Phase Reversal • Power Loss • Phase Loss L1 / L2 / L3 • Low Water Level • Pump On Demand • Low Ambient Temp. • Service Required

Audible and visible alarm shall be provided for: Fail To Start

Remote Alarm contacts shall be provided for:

Power Available • Phase Reversal • Motor Run • Common Pump Room Alarm (Overvoltage, Undervoltage, Phase Unbalance, Low/High Pump Room Temperature) • Common Motor Trouble (Overcurrent, Fail To Start, Undercurrent, Ground Fault)

1.8 Pressure and Event Recording

The system shall be capable of logging pressure data and operational events with time/date stamp. The system shall display operational events for the life-time of the controller and display the pressure data in text or graphical form. The controller shall log the Date/Time of the first start-up and the controller total power on time from that date. The controller shall log first and last statistics for: *First Setup · On Time · Start Count · Last Start Time · Min/Max/Average System Pressure · Min/Max/Average Pump Room Temp. · Jockey Pump On Time/Start Count/Last Start Time · Phase to Phase Voltages with Date Stamp · Amps Per Phase with Date Stamp*

1.9 USB Host Controller

A USB port capable of accepting a USB Flash Memory Disk shall be provided for downloading pressure and event logs.

2.0 Serial Communications

The controller shall feature Modbus with TCP/IP frame format and shielded female RJ45 connector

2.1 Pressure Sensing / Wet Parts

The controller shall be supplied with a solid state pressure transducer with a range of 0-500 psi calibrated for 0-300 psi (0-20.7 bar) and a run test solenoid valve. The wet parts shall be externally mounted and include a protective cover. The pressure sensing line connection to the transducer shall be 1/2-inch FNPT. Provisions for a redundant pressure transducer shall be provided.

2.2 Controller Operation

The controller shall be capable of automatic starting via pressure drop, remote start signal from an automatic device or a deluge valve. The controller can be manually started via the START push-button, the RUN TEST push-button, or a remote signal from a manual device. Stopping can be achieved manually with the STOP push-button or automatically after expiration of minimum run timer or test timer. The minimum run timer (off delay), sequential start timer (on delay) and periodic test timer shall be field adjustable and include a visual countdown on the display.

2.3 Manufacturer

The controller shall be a Firetrol brand.

Firetrol, Inc.

3362 Apex Peakway
Apex, North Carolina 27502
P +1 919 460 5200
F +1 919 460 5250
www.firetrol.com

While every precaution has been taken to ensure accuracy and completeness herein, Firetrol, Inc. assumes no responsibility, and disclaims all liability, for damages resulting from use of this information or for any errors or omissions. Specifications and drawings are subject to change without notice. ©2024 Firetrol, Inc., All Rights Reserved.

Publication SP-Elect

MARK^{III+} Electric Fire Pump Controllers

STARTING METHOD

FTA1000 Full Voltage Fire Pump Controllers are intended for use with electric motor driven fire pumps where the capacity of the power source permits full voltage starting. Full voltage is applied to the motor as soon as the controller is actuated. The controller monitors, displays and records fire pump system information.

Full voltage starting is simple and low cost and is preferred whenever the utility or emergency generator set will permit this type of starting.

FTA1250 Part Winding Starting Fire Pump Controllers can be used where the characteristics of the power source do not permit full voltage starting. The controller monitors, displays and records fire pump system information.

When the controller is actuated via pressure, START push-button, deluge valve contact, etc., the first contactor closes, connecting one of the motor windings to the line. During starting, the motor will draw approximately 65% of its normal locked rotor current and develop approximately 42% of its normal starting torque. After a time delay, the second contactor closes, connecting the second winding in parallel with the first. The motor then draws its normal running current and develops its rated torque.

FTA1300 Wye-Delta, Open Transition Starting Fire Pump Controllers are used with delta-wound squirrel cage motors. FTA1300 controllers are of the open circuit transition type in which the motor circuit is opened during the transition from start to run. The controller monitors, displays and records fire pump system information.

Actuating the controller by the pressure switch, START push-button or deluge valve contact closes the start contactor connecting the motor to the line in the wye connection. The motor will draw approximately 33% of its normal inrush current and develop approximately 33% of its normal starting torque. After a time delay, the motor is automatically reconnected in delta, applying full voltage to the motor windings. These controllers are recommended especially for use with generator sets.

FTA1350 Wye-Delta, Closed Transition Starting Fire Pump Controllers are used with delta-wound squirrel cage motors. These controllers are of the closed circuit transition type in which the motor circuit remains closed during the transition from start to run. The controller monitors, displays and records fire pump system information.

Actuating the controller via pressure, START push-button or deluge valve contact closes the start contactor connecting the motor to the line in the wye connection. The motor will draw approximately 33% of its normal inrush current and develop approximately 33% of its normal starting torque. After a time delay, the motor is automatically reconnected in delta, applying full voltage to the motor windings. During this transition, a resistor is connected to each phase, minimizing line disturbances and voltage drop during starting. These controllers are recommended especially for use with generator sets.

FTA1800 Autotransformer Starting Fire Pump Controllers use an autotransformer to supply reduced voltage when starting the motor. The controller is of the closed circuit type where the motor circuit remains closed during the transition from start to run resulting in minimum line disturbance.

The controller monitors, displays and records fire pump system information. The autotransformer has three taps for selection of starting current and torque; 50% tap for 150% current and 25% torque, 65% tap (factory setting) for 250% current and 42% torque and the 80% tap for 384% current and 64% torque.

FTA1930 Solid State Reduced Current Starting Fire Pump Controllers feature soft start, soft stop and system sensing capabilities that not only provide for reduced current starting, but also offer an improved level of hydro mechanical performance.

Approvals – Firetrol fire pump controllers are listed by Underwriters' Laboratories, Inc., in accordance with UL218, *Standard for Fire Pump Controllers*, CSA, *Standard for Industrial Control Equipment*, and approved by Factory Mutual. They are built to meet or exceed the requirements of the approving authorities as well as NEMA and the latest editions of NFPA 20, *Installation of Centrifugal Fire Pumps*, and NFPA 70, *National Electrical Code*.

Standard Features – The following are included as standard with each controller:

- Voltage surge protector
- Main Disconnect Switch sized for connected motor horsepower and voltage
- Fire pump Circuit Breaker
- Single Handle Isolating Disconnect Switch/Circuit Breaker mechanism
- Motor contactor
- Single Handle Emergency Manual Run Mechanism to mechanically close motor contactor contacts in an emergency condition
- Built-in Start and Stop push-buttons to bypass automatic start circuits
- Daylight Savings Time Option
- Elapsed Time Meter

Firetrol, Inc.

3362 Apex Peakway
Apex, North Carolina 27502
P +1 919 460 5200
F +1 919 460 5250
www.firetrol.com

While every precaution has been taken to ensure accuracy and completeness herein, Firetrol, Inc. assumes no responsibility, and disclaims all liability, for damages resulting from use of this information or for any errors or omissions. Specifications and drawings are subject to change without notice. ©2024 Firetrol, Inc., All Rights Reserved.

**FOR MODEL # INFORMATION SEE PUBLICATION SD-Electric
FOR OPTIONS AND MODIFICATIONS SEE PUBLICATION OP-Electric**

- 7.0" LCD capacitive type color touch screen (HMI technology) software upgradeable operator interface powered by an embedded microcomputer with software PLC logic.
- 500 PSI Pressure Transducer (calibrated for 300 PSI (20.7 Bar)) and Test Solenoid for fresh water applications, externally mounted with protective cover
- Audible alarm buzzer embedded in the MarkIII+
- Pump Room Ambient Temperature Switch, Display and Alarms
- Pressure and Event Recording with Date Stamp to System Memory Accessible VIA The User Interface and Downloadable to a USB Flash Drive
- Modbus Communications with TCP/IP frame format and a shielded female RJ45 connector
- NEMA Type 2 (IEC IP22) enclosure
- Suitable for use as Service Equipment
- The controller supplies visual indication of the following: Power Available • Motor Run • Periodic Test • Manual Start • Deluge Valve Start • Remote Automatic Start • Remote Manual Start • Emergency Start • Pump On Demand (Automatic Start) • Low Discharge Pressure • Pump Room Temp. • Lockout
- The controller displays visual indication for the following alarm conditions: Control Voltage Not Healthy • Fail To Start • Invalid Cut-In • Lock Rotor Current • Loss of Power • Low Ambient Temp. • Low Water Level • Motor Trouble • Phase Reversal • Overcurrent • Overvoltage • Phase Loss L1 / L2 / L3 • Phase Unbalanced • Pressure Transducer Fault Detected • Pump On Demand • Pump Room Alarm • Service Required • Undercurrent • Undervoltage • Check Test Solenoid • Weekly Test Cut-In Reached
- Audible and Visible Indication for Fail To Start.
- DPDT 8A, 250VAC remote alarm contacts are provided for: Power Available • Phase Reversal • Motor Run
 - Common Pump Room Alarm (Overvoltage / Undervoltage / Phase Unbalance / Low Pump Room Temp. / High Pump Room Temp)
 - Common Motor Trouble (Overcurrent / Fail To Start / Undercurrent / Ground Fault)
- Field Adjustable Timers with Visual Countdown for Minimum Run (Off Delay), Sequential Start (On Delay) and Weekly Test

Model Number Selection Guide



FTA1000 ~ FTA1930

MARK^{III+} Electric Fire Pump Controllers

FTA1000, 1250, 1300, 1350, 1800, 1930 ELECTRIC FIRE PUMP CONTROLLERS Example: FTA1300-AM75HH-xx

Starting Method
 1000 - Across-the-line (direct on line)
 1250 - Part Winding (50%-50% windings)
 1300 - Wye-delta (star-delta), open transition
 1350 - Wye-delta (star-delta), closed transition
 1800 - Autotransformer
 1930 - Digital Solid-state soft start/stop

Start/Stop Options
 A - Automatic/Manual start with manual stop only (default). Field configurable to automatic start with timed permissive stop after minimum run time and manual start with manual stop only.
 C - For Manual only operation of Foam Controllers (use option -LK3)

Modifications
 See Publication
 OP-Electric

Three Phase Voltage
 A - 220-240 Volt, 60 Hertz (230 V)
 AZ - 220-230 Volt, 50 Hertz
 B - 440-480 Volt, 60 Hertz (460 V)
 BZ - 415 Volt, 50 Hertz
 C - 550-600 Volt, 60 Hertz (575 V)
 F - 380 Volt, 60 Hertz
 FZ - 380 Volt, 50 Hertz
 FF - 400 Volt, 60 Hertz
 FX - 400 Volt, 50 Hertz
 H - 208 Volt, 60 Hertz
 HH - 200 Volt, 60 Hertz

Short Circuit Current Rating

Code	200-208V 5-150 HP	220-240V 5-200 HP	380-415V 5-350 HP	440-480V 5-400 HP	550-600V 5-500 HP
M - Standard	100kA	100kA	100kA	100kA	N/A
N - Intermediate	150kA	150kA	150kA	150kA	N/A
P - High	200kA	200kA	200kA	200kA	N/A
Q - Intermediate	N/A	N/A	N/A	N/A	100kA
R - Standard	N/A	N/A	N/A	N/A	50kA

Code	200-208V 200 HP	220-240V 250-400 HP	380-415V 400-500 HP	440-480V 450-500 HP
M - Standard	50A	50kA	50kA	50kA
N - Intermediate	N/A	N/A	N/A	N/A
P - High	100kA	100kA	100kA	100kA
Q - Intermediate	N/A	N/A	N/A	N/A
R - Standard	N/A	N/A	N/A	N/A

Horsepower Rating

03 - 3 HP	100 - 100 HP
05 - 5 HP	125 - 125 HP
07 - 7 1/2 HP	150 - 150 HP
10 - 10 HP	200 - 200 HP
15 - 15 HP	250 - 250 HP
20 - 20 HP	300 - 300 HP
25 - 25 HP	350 - 350 HP
30 - 30 HP	400 - 400 HP
40 - 40 HP	450 - 450 HP
50 - 50 HP	500 - 500 HP
60 - 60 HP	
75 - 75 HP	

For controller options and modifications see Publication OP-Electric

Firetrol, Inc.
 3362 Apex Peakway
 Apex, North Carolina 27502
 P +1 919 460 5200
 F +1 919 460 5250
 www.firetrol.com

While every precaution has been taken to ensure accuracy and completeness herein, Firetrol, Inc. assumes no responsibility, and disclaims all liability, for damages resulting from use of this information or for any errors or omissions. Specifications and drawings are subject to change without notice. ©2024 Firetrol, Inc., All Rights Reserved. Publication SD-Electric



MARK^{III+} Electric Fire Pump Controllers

SPECIAL ENCLOSURES

Option	Description
---	Enclosure, NEMA Type 2 (IEC IP22), Painted Steel (Standard)
-E	Enclosure, NEMA Type 4 (IEC IP65), Painted Steel
-F	Enclosure, NEMA Type 4X (IEC IP66), #304 Stainless Steel, Brushed Finish
-FD	Enclosure, NEMA Type 4X (IEC IP66), #316 Stainless Steel, Brushed Finish
-FDB	Enclosure, NEMA Type 4X (IEC IP66), #316 Stainless Steel, Seam Welded, Brushed Finish
-FDP	Enclosure, NEMA Type 4X (IEC IP66), #316 Stainless Steel, Painted Finish
-FXP	Enclosure, NEMA Type 4X (IEC IP66), #304 Stainless Steel, Painted Finish
-G	Enclosure, NEMA Type 12 (IEC IP54), Painted Steel
-T	Enclosure, NEMA Type 3R (IEC IP24), Painted Steel
-U	Enclosure, NEMA Type 3 (IEC IP54), Painted Steel

CIRCUIT BREAKER OPTION*

Option	Description									
Standard Short Circuit Current Rating										
-M	200-208V	220-240V	380-415V	440-480V	550-600V	200-208V	220-240V	380-415V	440-480V	
-R	5-150 HP	5-200 HP	5-350 HP	5-400 HP	5-500 HP	200 HP	250-400 HP	400-500 HP	450-500 HP	
	100kA (M)	100kA (M)	100kA (M)	100kA (M)	50kA (R)	50kA (M)	50kA (M)	50kA (M)	50kA (M)	
Intermediate Short Circuit Current Rating										
-N	200-208V	220-240V	380-415V	440-480V	550-600V	200-208V	220-240V	380-415V	440-480V	
-Q	5-150 HP	5-200 HP	5-350 HP	5-400 HP	5-500 HP	200 HP	250-400 HP	400-500 HP	450-500 HP	
	150kA (N)	150kA (N)	150kA (N)	150kA (N)	100kA (Q)	N/A	N/A	N/A	N/A	
High Short Circuit Current Rating										
-P	200-208V	220-240V	380-415V	440-480V	550-600V	200-208V	220-240V	380-415V	440-480V	
	5-150 HP	5-200 HP	5-350 HP	5-400 HP	5-500 HP	200 HP	250-400 HP	400-500 HP	450-500 HP	
	200kA	200kA	200kA	200kA	NA	100kA	100kA	100kA	100kA	

ANTI-CONDENSATION SPACE HEATERS

Option	Description
None	
-J	Space Heater, 120V Externally Powered with Circuit Breaker & Thermostat
-K	Space Heater, 120V Externally Powered with Circuit Breaker & Humidistat
-M	Space Heater, 240V Externally Powered with Circuit Breaker & Thermostat
-N	Space Heater, 240V Externally Powered with Circuit Breaker & Humidistat
-JKP	Space Heater, 120V Externally Powered with Circuit Breaker, Thermostat and Humidistat in Parallel
-MNP	Space Heater, 240V Externally Powered with Circuit Breaker, Thermostat and Humidistat in Parallel

PRESSURE TRANSDUCERS, SOLENOID VALVES, PLUMBING

Option	Description
---	Wetted Parts including Pressure Sensor and Test Solenoid, 300 PSI (20.4 Bar) Fresh Water
-B1	Wetted Parts including Pressure Sensor and Test Solenoid, 500 PSI (34.5 Bar) Fresh Water (For Factory Calibration Purposes Only)
-C1	Wetted Parts including Pressure Sensor and Test Solenoid, 300 PSI (20.4 Bar), Sea Water
-D1	Wetted Parts including Pressure Sensor and Test Solenoid, 500 PSI (34.5 Bar), Sea Water
-SP1	Low Suction Pressure Transducer, Fresh Water, 0-300 PSI (20.4 Bar) with Visible Indication and Output Contacts
-SP2	Low Suction Pressure Transducer, Sea Water, 0-300 PSI (20.4 Bar) with Visible Indication and Output Contacts

FOAM PUMP APPLICATIONS

Option

Description

Required For Foam

- LR1 Low Foam Level External Input, Visible Indications and Alarm Contacts, Additive with Provisions for Proof Pressure Switch Connection, With Lockout and Remote Alarm Indication For Interlock On (Locked Out)

Required For Foam

- LK1 Foam Pump Application With Pressure Transducer and Run Test Solenoid Valve (Auto. Start)
- LK2 Foam Pump Application With Pressure Transducer and Run Test Solenoid Valve, Stainless Steel (Auto. Start)
- LK3 Foam Pump Application Without Pressure Transducer and Run Test Solenoid Valve (Manual Start)

Optional For Foam

- DVC Operation, Dump Valve Control

ALARMS

Option

Description

- AC Extra Alarm Output Contacts, Pump Operating (2 Form-C)
- AM Alarm Output Contacts, Fail to Start
- AV Alarm Output Contacts, Low Pump Room Temperature
- AW Alarm Output Contacts, Reservoir Low
- AY1 Configurable Low Suction Pressure, Visible/Output Contacts with External Digital Input
- BWI Extra Alarm Output Contacts, Phase Failure/Phase Reversal
- BY1 Alarm Output Contacts, Overcurrent
- CTSI Configurable Low Suction Pressure, Visible/Output Contacts with Suction Pressure Transducer
- EHI Alarm Output Contacts, Main Relief Valve Open
- EK Alarm Output Contacts, Flow Meter Open
- JR Visible Indicator, Jockey Pump Operating
- JT Alarm, Audible/Visible, Jockey Pump Trouble
- KH Alarm Output Contacts, Common Alarm
- PI Alarm, Audible/Visible, Built-In 120V Supervisory System (Includes Visible Supervisory Voltage Normal Indication and Audible Pump Operating, Phase Failure and Phase Reversal Indication)
- PE Alarm Output Contacts, Low System Pressure (Pump on Demand)
- PT Alarm, Audible/Visible, Built-In 240V Supervisory System (Includes Visible Supervisory Voltage Normal Indication and Audible Pump Operating, Phase Failure and Phase Reversal Indication)

MISCELLANEOUS

Option

Description

- ED2 Normal Source Load Shedding with Adjustable Time Delay to Remove Non-Critical Loads Before Starting
- EL Series Pumping Operation, High Zone Controller
- EM Series Pumping Operation, Mid Zone Controller
- EN Series Pumping Operation, Low Zone Controller
- IEC Marking, CE with External Wet Parts (Requires NEMA Type 12 (IP54) Enclosure as Minimum)
- MZN Neutral Lug, Service Entrance, Non-Insulated Bonded to Enclosure
- OSP Seismic Certification compliant to OSHPD (CA) for rigid base or wall mount only
- PK Terminal Blocks, Extra Remote Start
- PY Output Contacts, Motor Space Heater, Externally Powered
- S Tropicalization
- SEI Seismic Certification compliant to CBC 2022, IBC 2021 for rigid base or wall mount only

-USBX	Data Port, External USB
-Y55	Controller Temperature Rating, 55°C (131°F) Ambient Temperature
-ZPM1	Data Port, RS-485 Modbus RTU
-XCR	Export Packaging (Wooden Crating to Conform to IPPC Standards)

Firetrol, Inc.

3362 Apex Peakway
Apex, North Carolina 27502
P +1 919 460 5200
F +1 919 460 5250
www.firetrol.com

While every precaution has been taken to ensure accuracy and completeness herein, Firetrol, Inc. assumes no responsibility, and disclaims all liability, for damages resulting from use of this information or for any errors or omissions. Specifications and drawings are subject to change without notice. ©2024 Firetrol, Inc., All Rights Reserved.



© Firetrol, Inc. Not for construction.
Subject to change without notice.

BY		DD/MM/YY
DRAWN BY	MLC	04/10/24
FINAL APPROVAL	FC	07/11/24

ELECTRIC FIRE PUMP CONTROLLER

MODEL: FTA1000/FTA1250/FTA1300

BUILT TO THE LATEST EDITION OF THE NFPA20 & NFPA70



DRAWING NUMBER	DD1000-930/E
DWG REV. 0	
SHEET 1 OF 1	

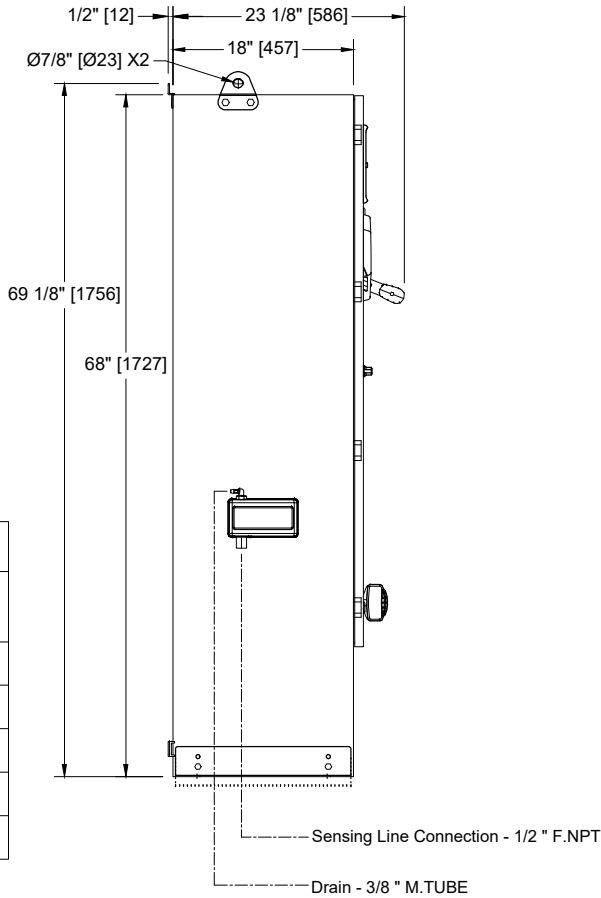

Voltage	Min HP	Max HP
208	75	150
220 - 240	100	200
380 - 400 - 415	150	300
440 - 480	200	350
600	200	500

Notes:

- Standard: NEMA 2
- Standard paint : textured red RAL 3002.
- All dimensions are in inches [millimeters].
- Center of screen: 61-5/8" [1564] from bottom.
- Bottom conduit entrance through removable gland plate recommended.
- Use watertight conduit and connector only.
- Protect equipment against drilling chips.
- Door swing equal to door width.

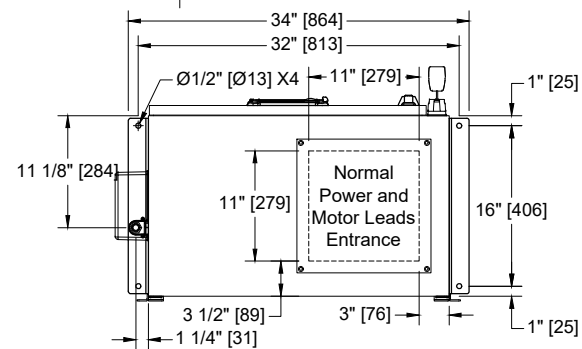
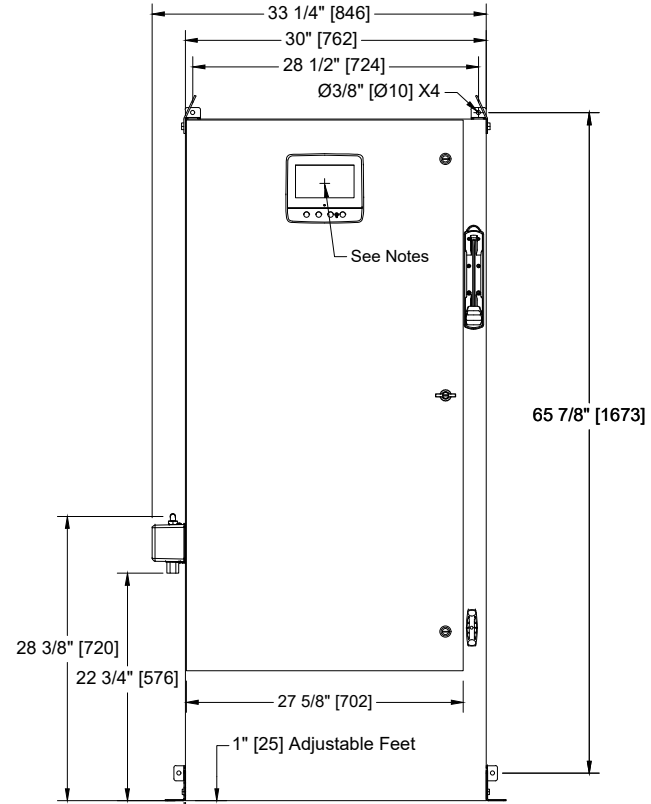



© Firetrol, Inc. Not for construction.
Subject to change without notice.

BY		DD/MM/YY
DRAWN BY	ACD	28/02/23
FINAL APPROVAL	FC	28/02/23

ELECTRIC FIRE PUMP CONTROLLER FULL VOLTAGE / ACROSS THE LINE

MODEL:FTA1000

BUILT TO THE LATEST EDITION OF THE NFPA20 & NFPA70



DRAWING NUMBER	WS1000-800/E
DWG REV. 0	
SHEET 1 OF 2	

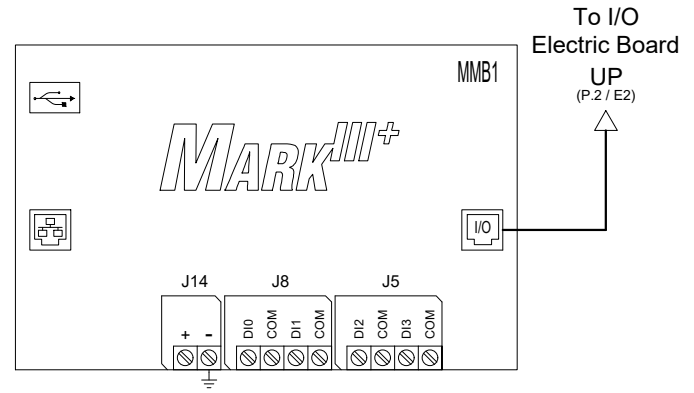
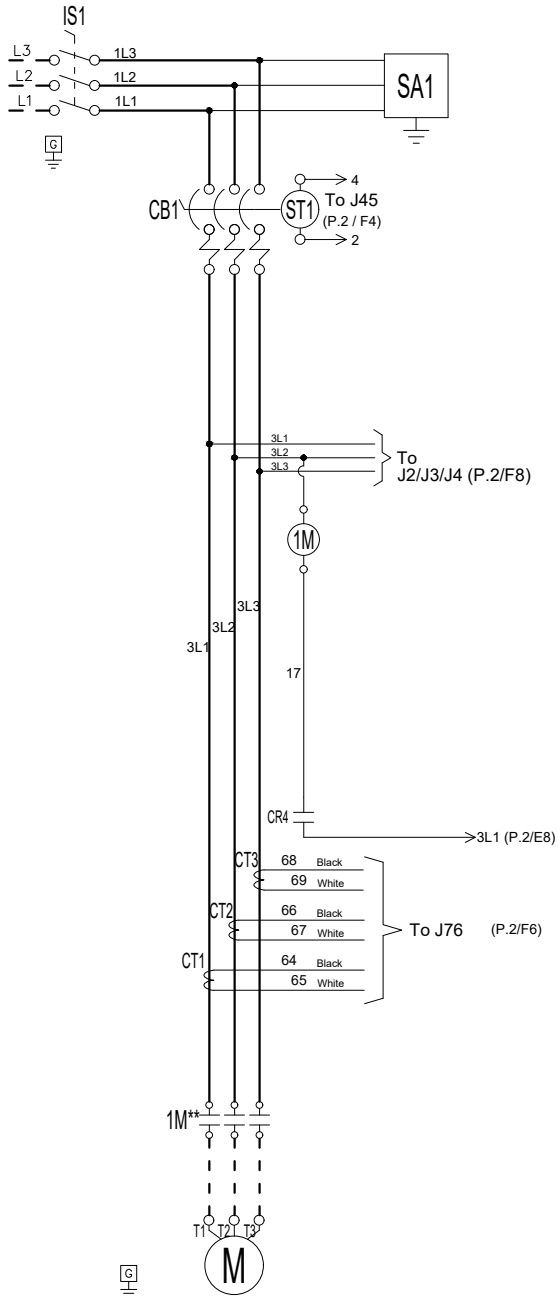

Legend	
1M	Contactor
AB	Alarm Bell
CB	Circuit Breaker
CR	Control Relay
CT	Current Transformer
EB	Electric I/O Board
IS	Isolating Switch
J	Jumper
LS	Limit Switch
PT	Pressure Transducer
SA	Surge Arrester
ST	Shunt Trip
SV	Solenoid Valve
MMB	Main Board
XTR	Transformer



© Firetrol, Inc. Not for construction. Subject to change without notice.

BY		DD/MM/YY	
DRAWN BY	ACD	28/02/23	
FINAL APPROVAL	FC	28/02/23	

ELECTRIC FIRE PUMP CONTROLLER FULL VOLTAGE / ACROSS THE LINE

MODEL:FTA1000

BUILT TO THE LATEST EDITION OF THE NFPA20 & NFPA70



DRAWING NUMBER	WS1000-800/E
DWG REV. 0	
SHEET 2 OF 2	

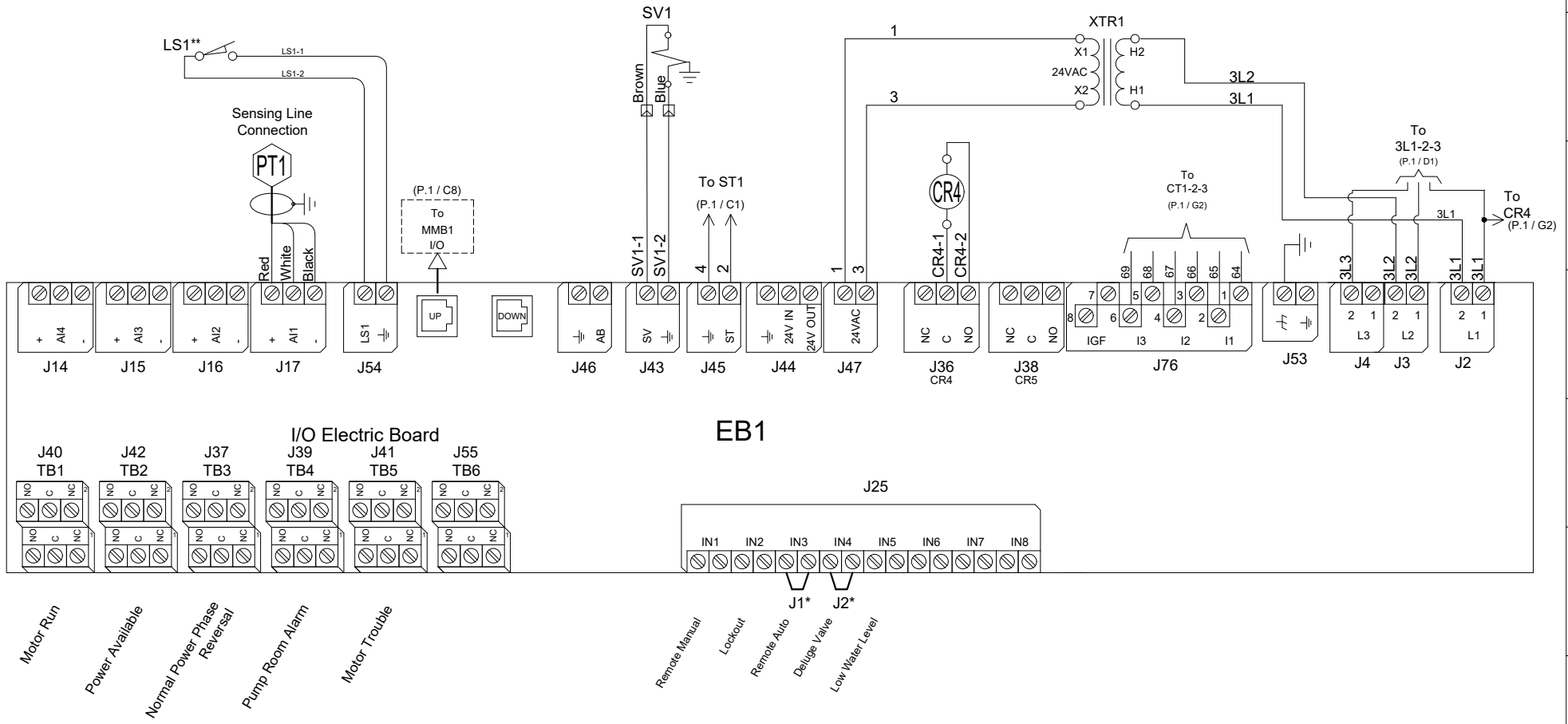

* Remove jumper to use this feature
 ** Contact closes when emergency start is in "ON" position



© Firetrol, Inc. Not for construction.
Subject to change without notice.

BY		DD/MM/YY	
DRAWN BY	MLC	04/10/24	
FINAL APPROVAL	FC	07/11/24	

ELECTRIC FIRE PUMP CONTROLLER

MODEL:FTA1000/FTA1250/FTA1300

BUILT TO THE LATEST EDITION OF THE NFPA20 & NFPA70



DRAWING NUMBER	FC1000-907/E
DWG REV. 0	
SHEET 1 OF 1	

COPPER CONDUCTORS for Isolating Switch (IS1).

Field Wiring According to Bending Space (AWG or MCM). Terminals L1 - L2 - L3

Bending Space	5" (127 mm)							8" (203 mm)			
	HP	5	7.5	10	15	20	25	30	40	50	60
208	208	1x (10 to 1/0)	1x (8 to 1/0)	1x (8 to 1/0)	1x (6 to 1/0)	1x (4 to 1/0)	1x (3 to 1/0)	1x (2 to 1/0)	1x (1/0 to 3/0)	1x (3/0 to 250)	1x (4/0 to 250)
220 to 240	220 to 240	1x (10 to 1/0)	1x (10 to 1/0)	1x (8 to 1/0)	1x (6 to 1/0)	1x (4 to 1/0)	1x (4 to 1/0)	1x (3 to 1/0)	1x (1 to 3/0)	1x (2/0 to 3/0)	1x (3/0 to 250)
380 to 416	380 to 416	1x (10 to 1/0)	1x (10 to 1/0)	1x (10 to 1/0)	1x (8 to 1/0)	1x (8 to 1/0)	1x (6 to 1/0)	1x (6 to 1/0)	1x (4 to 1/0)	1x (3 to 1/0)	1x (1 to 1/0)
440 to 480	440 to 480	1x (10 to 1/0)	1x (10 to 1/0)	1x (10 to 1/0)	1x (10 to 1/0)	1x (8 to 1/0)	1x (8 to 1/0)	1x (6 to 1/0)	1x (6 to 1/0)	1x (4 to 1/0)	1x (3 to 1/0)
600	600	1x (10 to 1/0)	1x (10 to 1/0)	1x (10 to 1/0)	1x (10 to 1/0)	1x (10 to 1/0)	1x (8 to 1/0)	1x (8 to 1/0)	1x (6 to 1/0)	1x (6 to 1/0)	1x (4 to 1/0)

Power Terminals

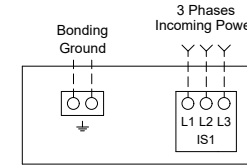

Bending Space	12" (305 mm)				16" (406 mm)***							
	HP	75	100	125	150	200	250	300	350	400	450	500
208	208	2x (1/0 to 500)	2x (2/0 to 500)	2x (4/0 to 500)	2x (250 to 500)	3x (4/0 to 500)	-----	-----	-----	-----	-----	-----
220 to 240	220 to 240	1x (250)	2x (2/0 to 500)	2x (3/0 to 500)	2x (4/0 to 500)	2x (350 to 500)	3x (250 to 500)	-----	-----	-----	-----	-----
380 to 416	380 to 416	1x (1/0 to 250)	1x (3/0 to 250)	1x (250)	1x (300 to 500)	1x (500)	2x (4/0 to 500)	2x (300 to 500)	3x (4/0 to 500)	3x (250 to 500)	4x (3/0 to 500)	-----
440 to 480	440 to 480	1x (1 to 250)	1x (2/0 to 250)	1x (3/0 to 250)	1x (4/0 to 250)	1x (350 to 500)	1x (500)	2x (4/0 to 500)	2x (300 to 500)	3x (3/0 to 500)	3x (4/0 to 500)	3x (250 to 500)
600	600	1x (3 to 1/0)	1x (1 to 250)	1x (2/0 to 250)	1x (3/0 to 250)	1x (250 to 500)	1x (350 to 500)	1x (500)	2x (4/0 to 500)	2x (250 to 500)	2x (300 to 500)	2x (350 to 500)
Bending Space	Bending Space	5" (127 mm)			8" (203 mm)				12" (305 mm)			

***Only for 16"(406 mm) bending space

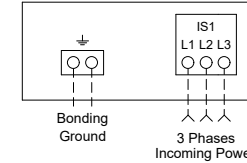

ALUMINUM CONDUCTORS for Isolating Switch (IS1).***

Field Wiring According to Bending Space (AWG or MCM). Terminals L1 - L2 - L3

Bending Space	5" (127 mm)							8" (203 mm)		10" (254 mm)	
	HP	5	7.5	10	15	20	25	30	40	50	60
208	208	1x (10 to 1/0)	1x (6 to 1/0)	1x (6 to 1/0)	1x (4 to 1/0)	1x (3 to 1/0)	1x (1 to 1/0)	1x (1/0)	1x (3/0)	1x (4/0 to 250)	1x (300) ** or 1x (250) 90°C *
220 to 240	220 to 240	1x (10 to 1/0)	1x (8 to 1/0)	1x (6 to 1/0)	1x (4 to 1/0)	1x (3 to 1/0)	1x (2 to 1/0)	1x (1 to 1/0)	1x (2/0 to 3/0)	1x (3/0) 90°C *	1x (250)
380 to 416	380 to 416	1x (10 to 1/0)	1x (10 to 1/0)	1x (10 to 1/0)	1x (6 to 1/0)	1x (6 to 1/0)	1x (4 to 1/0)	1x (4 to 1/0)	1x (2 to 1/0)	1x (1 to 1/0)	1x (1/0)
440 to 480	440 to 480	1x (10 to 1/0)	1x (10 to 1/0)	1x (10 to 1/0)	1x (8 to 1/0)	1x (6 to 1/0)	1x (6 to 1/0)	1x (4 to 1/0)	1x (4 to 1/0)	1x (2 to 1/0)	1x (1 to 1/0)
600	600	1x (10 to 1/0)	1x (10 to 1/0)	1x (10 to 1/0)	1x (10 to 1/0)	1x (8 to 1/0)	1x (6 to 1/0)	1x (6 to 1/0)	1x (4 to 1/0)	1x (4 to 1/0)	1x (2 to 1/0)

Bending Space	12" (305 mm)				16" (406 mm)***							
	HP	75	100	125	150	200	250	300	350	400	450	500
208	208	2x (2/0 to 500)	2x (4/0 to 500)	2x (300 to 500)	2x (350 to 500)	3x (300 to 500)	-----	-----	-----	-----	-----	-----
220 to 240	220 to 240	1x (350) ** N/A	2x (3/0 to 500)	2x (250 to 500)	2x (300 to 500)	2x (500)	3x (400 to 500)	-----	-----	-----	-----	-----
380 to 416	380 to 416	1x (3/0 to 250)	1x (250)	Consult Factory	1x (500)	Consult Factory	2x (300 to 500)	2x (500)	3x (300 to 500)	3x (350 to 500)	3x (400 to 500)	-----
440 to 480	440 to 480	1x (1/0 to 250)	1x (3/0 to 250)	1x (250)	1x (250) 90°C *	1x (500)	Consult Factory	2x (300 to 500)	2x (400 to 500)	3x (250 to 500)	3x (300 to 500)	3x (350 to 500)
600	600	1x (1 to 1/0)	1x (2/0 to 250)	1x (4/0 to 250)	1x (4/0 to 250)	1x (350 to 500)	1x (500)	Consult Factory	2x (300 to 500)	2x (350 to 500)	2x (400 to 500)	2x (500)
Bending Space	Bending Space	5" (127 mm)			8" (203 mm)				12" (305 mm)			

Notes:

- 1 - For proper wire sizing, refer to NFPA70 and NEC (USA) or CEC (Canada) or local code.
- 2 - Controller suitable for use as service equipment in USA.
- 3 - Controller use as service equipment prohibited in Canada.
- 4 - For more accurate motor connections refer to motor manufacturer or motor nameplate.
- 5 - Controller is phase sensitive. Incoming lines must be connected in ABC sequence.

Drawing for information only.
Manufacturer reserves the right to modify this drawing without notice.
Contact manufacturer for "As Built" drawing.

*For standard enclosure, use 90°C aluminium wire. Consult Factory for Use of Conductors Rated Lower than 90°C.

** Consult Factory

*** Aluminum is not permitted in Canada.



© Firetrol, Inc. Not for construction.
Subject to change without notice.

BY		DD/MM/YY
DRAWN BY	MLC	04/10/24
FINAL APPROVAL	FC	07/11/24

ELECTRIC FIRE PUMP CONTROLLER

MODEL:FTA1000

BUILT TO THE LATEST EDITION OF THE NFPA20 & NFPA70



DRAWING NUMBER	FC1000-901/E
DWG REV. 0	
SHEET 1 OF 1	

COPPER CONDUCTORS for Motor Connection (1M).

Field Wiring According to Bending Space (AWG or MCM). Terminals T1 - T2 - T3

HP Voltage	5	7.5	10	15	20	25	30	40	50	60
208	1x (10 to 2)	1x (8 to 2)	1x (8 to 2)	1x (6 to 2)	1x (4 to 2)	1x (3 to 2/0)	1x (2 to 2/0)	1x (1/0 to 3/0)	1x (3/0)	1x (4/0 to 300)
220 to 240	1x (10 to 2)	1x (10 to 2)	1x (8 to 2)	1x (6 to 2)	1x (4 to 2)	1x (4 to 2/0)	1x (3 to 2/0)	1x (1 to 3/0)	1x (2/0 to 3/0)	1x (3/0)
380 to 416	1x (10 to 4)	1x (10 to 4)	1x (10 to 4)	1x (8 to 4)	1x (8 to 4)	1x (6 to 4)	1x (6 to 4)	1x (4 to 2)	1x (3 to 2)	1x (1 to 2/0)
440 to 480	1x (10 to 4)	1x (10 to 4)	1x (10 to 4)	1x (10 to 4)	1x (8 to 4)	1x (8 to 4)	1x (6 to 4)	1x (6 to 4)	1x (4 to 2)	1x (3 to 2/0)
600	1x (10 to 4)	1x (10 to 4)	1x (10 to 4)	1x (10 to 4)	1x (10 to 4)	1x (8 to 4)	1x (8 to 4)	1x (6 to 4)	1x (6 to 2)	1x (4 to 2/0)

HP Voltage	75	100	125	150	200	250	300	350	400	450	500
208	1x (300)	2x (2/0 to 300)	2x (4/0 to 300)	2x (250 to 300)	2x (400 to 600)	-----	-----	-----	-----	-----	-----
220 to 240	1x (250 to 300)	2x (2/0 to 300)	2x (3/0 to 300)	2x (4/0 to 300)	2x (350 to 500)	2x (500 to 600)	-----	-----	-----	-----	-----
380 to 416	1x (1/0 to 3/0)	1x (3/0)	1x (250 to 300)	1x (300)	2x (3/0 to 300)	2x (4/0 to 300)	2x (300 to 600)	2x (400 to 600)	2x (500 to 600)	2x (600)	-----
440 to 480	1x (1 to 2/0)	1x (2/0 to 3/0)	1x (3/0 to 300)	1x (4/0 to 300)	2x (1/0 to 300)	2x (3/0 to 300)	2x (4/0 to 600)	2x (300 to 600)	2x (350 to 600)	2x (400 to 600)	2x (500 to 600)
600	1x (3 to 2/0)	1x (1 to 3/0)	1x (2/0 to 300)	1x (3/0 to 300)	2x (1 to 300)	2x (2/0 to 300)	2x (3/0 to 300)	2x (4/0 to 600)	2x (250 to 600)	2x (300 to 600)	2x (350 to 600)

Motor Terminals

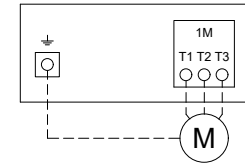

Model: FTA1000

ALUMINUM CONDUCTORS for Contactor (1M).***

Field Wiring According to Bending Space (AWG or MCM). Terminals T1 - T2 - T3

HP Voltage	5	7.5	10	15	20	25	30	40	50	60
208	1x (10 to 2/0) **	1x (10 to 2/0) **	1x (6 to 2/0) **	1x (4 to 2/0) **	1x (3 to 2/0) **	1x (1 to 2/0) **	1x (1/0 to 2/0) **	1x (2/0) 90°C *	Consult Factory	1x (300)
220 to 240	1x (10 to 2/0) **	1x (10 to 2/0) **	1x (8 to 2/0) **	1x (4 to 2/0) **	1x (3 to 2/0) **	1x (2 to 2/0) **	1x (1 to 2/0) **	1x (2/0)	1x (3/0) 90°C *	Consult Factory
380 to 416	1x (12 to 2/0) **	1x (12 to 2/0) **	1x (10 to 2/0) **	1x (8 to 2/0) **	1x (6 to 2/0) **	1x (4 to 2/0) **	1x (4 to 2/0) **	1x (2 to 2/0) **	1x (1 to 2/0) **	1x (1/0 to 2/0)
440 to 480	1x (12 to 2/0) **	1x (12 to 2/0) **	1x (10 to 2/0) **	1x (8 to 2/0) **	1x (8 to 2/0) **	1x (6 to 2/0) **	1x (6 to 2/0) **	1x (4 to 2/0) **	1x (2 to 2/0) **	1x (1 to 2/0)
600	1x (12 to 2/0) **	1x (12 to 2/0) **	1x (12 to 2/0) **	1x (10 to 2/0) **	1x (8 to 2/0) **	1x (8 to 2/0) **	1x (8 to 2/0) **	1x (4 to 2/0) **	1x (4 to 2/0) **	1x (2 to 2/0)

HP Voltage	75	100	125	150	200	250	300	350	400	450	500
208	1x (300) 90°C *	2x (4/0 to 300)	2x (300)	2x (300) 90°C *	2x (600)	-----	-----	-----	-----	-----	-----
220 to 240	1x (300) 90°C *	2x (3/0 to 300)	2x (250 to 300)	2x (300)	2x (500)	2x (600)	-----	-----	-----	-----	-----
380 to 416	1x (3/0)	Consult Factory	1x (300) 90°C *	Consult Factory	2x (4/0 to 300)	2x (300)	2x (500 to 600)	2x (600)	2x (600) 90°C *	2x (600) 90°C *	-----
440 to 480	1x (1/0 to 2/0)	1x (3/0)	1x (250 to 300)	1x (300)	2x (3/0 to 300)	2x (250 to 300)	2x (300 to 600)	2x (400 to 600)	2x (500 to 600)	2x (600)	2x (600) 90°C *
600	1x (1 to 2/0)	1x (2/0 to 3/0)	1x (4/0 to 300)	1x (4/0 to 300)	2x (1/0 to 300)	2x (3/0 to 300)	2x (4/0 to 300)	2x (300 to 600)	2x (350 to 600)	2x (400 to 600)	2x (500 to 600)

*For standard enclosure, use 90°C aluminium wire. Consult Factory for Use of Conductors Rated Lower than 90°C.

** Option V659 required.

*** Aluminum is not permitted in Canada.

Notes:

- 1 - For proper wire sizing, refer to NFPA70 and NEC (USA) or CEC (Canada) or local code.
- 2 - Controller suitable for use as service equipment in USA.
- 3 - Controller use as service equipment prohibited in Canada.
- 4 - For more accurate motor connections refer to motor manufacturer or motor nameplate.
- 5 - Controller is phase sensitive. Incoming lines must be connected in ABC sequence.

Drawing for information only.
Manufacturer reserves the right to modify this drawing without notice.
Contact manufacturer for "As Built" drawing.



© Firetrol, Inc. Not for construction.
Subject to change without notice.

BY		DD/MM/YY	
DRAWN BY	ACD	18/12/23	
FINAL APPROVAL	FC	19/12/23	

ELECTRIC FIRE PUMP CONTROLLER

MODEL:FTA1000

BUILT TO THE LATEST EDITION OF THE NFPA20 & NFPA70



DRAWING NUMBER	FC1000-803/E
DWG REV. 0	
SHEET 1 OF 1	

Field Connections

Terminals Wire Size:
24 - 12 AWG
0.5 Nm

- Remote Manual
- Lockout
- Remote Auto
- Deluge Valve
- Low Water Level

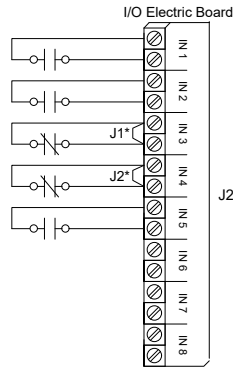

Network Connections

Terminals Wire Size:
Shielded Female Connector RJ45

Modbus TCP/IP RJ45

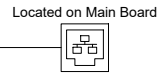

Alarm Contacts

Terminals Wire Size:
24 - 12 AWG
0.5 Nm

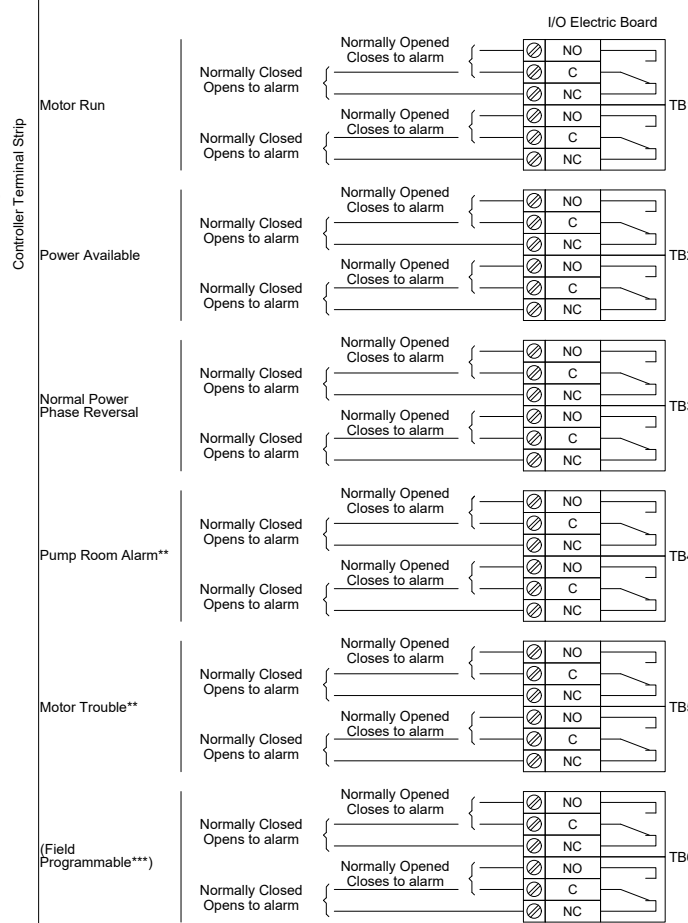

* Remove jumper to use this feature
** Re-assignable
*** Not available on FTA1930 models



© Firetrol, Inc. Not for construction.
Subject to change without notice.

	BY	DD/MM/YY
DRAWN BY	ACD	21/11/24
FINAL APPROVAL	FC	21/11/24

ELECTRIC FIRE PUMP CONTROLLER MOTOR CONNECTIONS

MODEL: FTA1000/FTA1800/FTA1930

DRAWING NUMBER	MC1000-001/E
DWG REV.	2
SHEET 1 OF 1	

IMPORTANT : - NFPA 20-2022 Art. 9.5.3.2 :
A MOTOR TERMINAL CONNECTING DIAGRAM FOR MULTIPLE LEAD
MOTORS SHALL BE FURNISHED BY THE MOTOR MANUFACTURER.

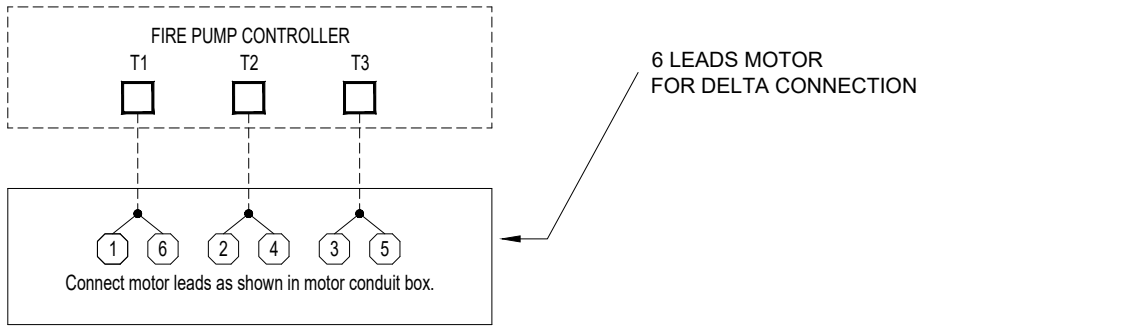
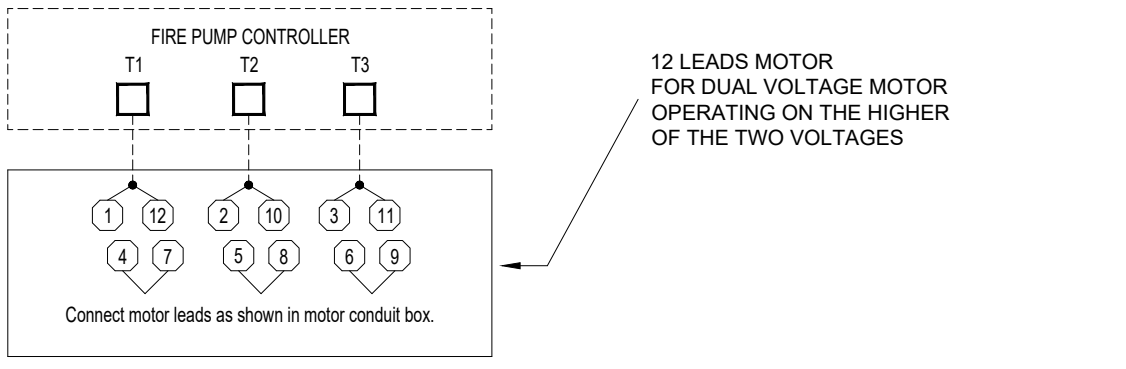
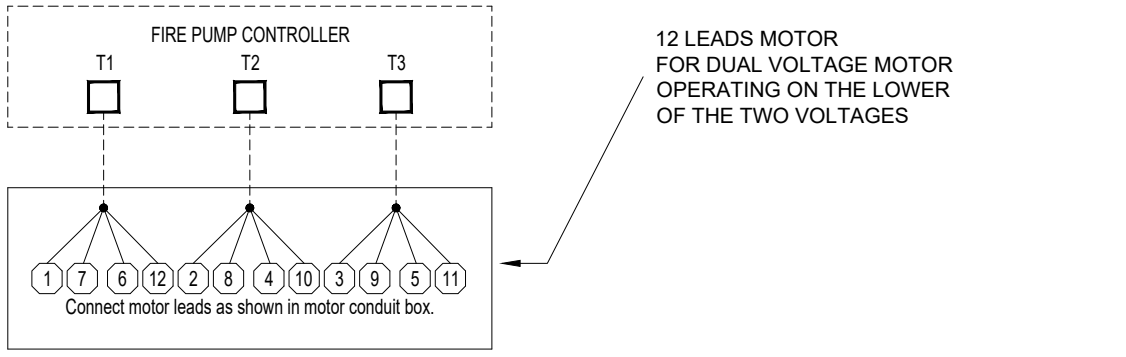

**Firetrol Inc. ASSUMES NO LIABILITY
FOR INCORRECT WIRING OF THE
MOTOR TO THE CONTROLLER**

WARNING :
- THIS DRAWING IS FOR GENERAL INFORMATION.
- CONSULT MOTOR MANUFACTURER BEFORE CONNECTING TO CONTROLLER.
- CONNECT MOTOR LEADS AS SHOWN IN MOTOR CONDUIT BOX