



**MARK<sup>III+</sup> Electric Fire Pump Controller - Wye-Delta Open Transition Starting With Power Transfer Switch**

Project Information

Voltage / Power Table		
Voltage	Min HP	Max HP
208	200	
220 - 240	250	

**DRAWINGS INCLUDED IN THIS PACKAGE ARE FOR STANDARD CONTROLLERS. ACTUAL "AS BUILT" DRAWINGS MAY DIFFER FROM THOSE SHOWN HERE.**

***Firetrol, Inc.***

3362 Apex Peakway  
Apex, North Carolina 27502  
P +1 919 460 5200  
F +1 919 460 5250  
www.firetrol.com

While every precaution has been taken to ensure accuracy and completeness herein, Firetrol, Inc. assumes no responsibility, and disclaims all liability, for damages resulting from use of this information or for any errors or omissions. Specifications and drawings are subject to change without notice.  
©2023 Firetrol, Inc., All Rights Reserved.

# Firetrol MARK<sup>III+</sup> Electric Fire Pump Controller

FTA1300/FTA950 – Wye-Delta Open Transition Starting with Power Transfer Switch  
Specifications

## 1.0 Main Fire Pump Controller

The main fire pump controller shall be a factory assembled, wired and tested unit. The controller shall be of the combined manual and automatic type designed for full voltage starting of the fire pump motor having the horsepower, voltage, phase and frequency rating shown on the plans and drawings. The controller shall be rated for an Ambient Temperature Operating Range of 39°F (4°C) to 104°F (40°C).

## 1.1 Standards, Listings & Approvals

The controller shall conform to all the requirements of the latest editions of:  
NFPA 20, *Standard for the Installation of Stationary Pumps for Fire Protection*  
NFPA 70, *National Electrical Code*.

The controller shall be listed by:

Underwriters Laboratories, Inc., in accordance with UL218, *Standard for Fire Pump Controllers* Canadian Standards Association CSA-C22.2, *Standard for Industrial Control Equipment (cUL)*  
CE – Low Voltage Directive

The controller shall be approved by:

Factory Mutual (IEC 62091)  
The City of New York for fire pump service

## 1.2 Enclosure

The controller components shall be housed in a NEMA Type 2 (IEC IP22) drip-proof, wall mounted enclosure.

## 1.3 Withstand Ratings (Short Circuit Current Ratings)

All controller components shall be front mounted, wired and front accessible for maintenance. The available short circuit current ratings are shown below. The ratings shall apply to the normal and emergency power components.

Code	200-208V 5-150 HP	220-240V 5-200 HP	380-415V 5-350 HP	440-480 5-400 HP	550-600 5-500 HP
M - Standard	100kA	100kA	100kA	100kA	N/A
N - Intermediate	150kA	150kA	150kA	150kA	N/A
P - High	200kA	200kA	200kA	200kA	N/A
Q - Intermediate	N/A	N/A	N/A	N/A	100kA
R - Standard	N/A	N/A	N/A	N/A	50kA
Code	200-208V 200 HP	220-240V 250-400 HP	380-415V 400-500 HP	440-480 450-500 HP	
M - Standard	50A	50kA	50kA	50kA	
N - Intermediate	N/A	N/A	N/A	N/A	
P - High	100kA	100kA	100kA	100kA	
Q - Intermediate	N/A	N/A	N/A	N/A	
R - Standard	N/A	N/A	N/A	N/A	

## 1.4 Power Components

The controller shall include a combination isolating disconnect switch/circuit breaker, rated for not less than 115% of the motor full load current, mechanically interlocked and operated with a single, externally mounted handle. The isolating disconnect switch/circuit breaker shall be mechanically interlocked so that the enclosure door cannot be opened with the handle in the ON position except by a hidden tool operated bypass mechanism. The isolating disconnect switch/circuit breaker shall be capable of being

padlocked in the OFF position for installation and maintenance safety, and shall also be capable of being locked in the ON position without affecting the tripping characteristics of the circuit breaker.

The controller will include a voltage surge arrester and Wye-Delta Open Transition motor starter.

The controller shall be equipped with a single handle, manually operated, emergency start mechanism capable of being latched in the ON position.

The controller shall include an Automatic Transfer Switch, electrically or manually operated, mechanically held.

## 1.5 Operator Interface (HMI)

The operator interface shall be a 7.0" LCD capacitive type color touch screen (HMI technology) powered by an embedded microcomputer with software PLC logic. Included shall be keypad type push-buttons for START, STOP, RUN TEST and TRANSFER SWITCH TEST.

The screen shall include menus for: *Home · Alarms · Configuration · History · Service · Manuals · Language.*

The HMI shall graphically display the following: *Voltage and Amperage of all 3 phases simultaneously using true RMS Technology for both the Normal and Alternate Power Sources · Transfer Switch Status · Motor Stopped/Running · Starting Cause · Actuation Mode · Controller Type · Shutdown Mode · Date & Time · Pump Room Temp. · System Pressure*

System pressure shall be capable of being displayed as: *PSI, kPa, Bar, Feet of Head or Meters of Water.*

The HMI shall allow programming and display of: *Cut In & Cut Out Pressure Settings · Minimum Run Timer · Sequential Start Timer · Periodic Test Timer*

The HMI allows the user to select the language of the system and download the manual or view the manual on screen.

## 1.6 State and Alarm Indication

Visual indication shall be provided for the following:

Power Available • Motor Run • Periodic Test • Manual Start • Deluge Valve Start • Remote Automatic Start • Remote Manual Start • Emergency Start • Pump On Demand/Automatic Start • Pump Room Temperature • Lockout

The digital display shall visually indicate the following alarms:

Alternate Power Lock Rotor Current • Alternate Power Phase Reversal • Automatic Power Transfer Switch Trouble • Locked Rotor Current • Fail To Start • Under/Over Current • Under/Over Voltage • Phase Unbalance • Check Test Solenoid Valve • Weekly Test Cut-In Not Reached • Transducer Fault • Control Voltage Not Healthy • Motor Trouble • Pump Room Alarm • Invalid Cut-In • Phase Reversal • Power Loss • Phase Loss L1 / L2 / L3 • Low Water Level • Pump On Demand • Low Ambient Temp. • Service Required

Audible and visible alarm shall be provided for:

Fail To Start • Alternate Circuit Breaker Off or Tripped • Alternate Isolating Switch Tripped/Open •

Remote Alarm contacts shall be provided for:

Power Available • Phase Reversal • Motor Run • Common Pump Room Alarm (Overvoltage, Undervoltage, Phase Unbalance, Low/High Pump Room Temperature) • Common Motor

Trouble (Overcurrent, Fail To Start, Undercurrent, Ground Fault) • Transfer Switch in Normal Position • Transfer Switch in Alternate Position • Alternate Power Isolating Switch Off

## 1.7 Pressure and Event Recording

The system shall be capable of logging pressure data and operational events with time/date stamp. The system shall display operational events for the lifetime of the controller and display the pressure data in text or graphical form. The controller shall log the Date/Time of the first start-up and the controller total power on time from that date. The controller shall log first and last statistics for: *First Setup · On Time · Start Count · Last Start Time · Min/Max/Average System Pressure · Min/Max/Average Pump Room Temp. · Jockey Pump On Time/Start Count/Last Start Time · Phase to Phase Voltages with Date Stamp · Amps Per Phase with Date Stamp*

## 1.8 USB Host Controller

A USB port capable of accepting a USB Flash Memory Disk shall be provided for downloading pressure and event logs.

## 1.9 Serial Communications

The controller shall feature Modbus with TCP/IP frame format and shielded female RJ45 connector

## 2.0 Pressure Sensing / Wet Parts

The controller shall be supplied with a solid state pressure transducer with a range of 0-500 psi calibrated for 0-300 psi (0-20.7 bar) and a run test solenoid valve. The wet parts shall be externally mounted and include a protective cover. The pressure sensing line connection to the transducer shall be 1/2-inch FNPT. Provisions for a redundant pressure transducer shall be provided.

## 2.1 Controller Operation

The controller shall be capable of automatic starting via pressure drop, remote start signal from an automatic device or a deluge valve. The controller can be manually started via the START push-button, the RUN TEST push-button, or a remote signal from a manual device. Stopping can be achieved manually with the STOP push-button or automatically after expiration of minimum run timer or test timer. The minimum run timer (off delay), sequential start timer (on delay) and periodic test timer shall be field adjustable and include a visual countdown on the display. Adjustable timers shall be supplied for Momentary Normal Power Outage Override, Alternate Power Available Delay, Transfer Trouble Delay, Retransfer To Normal, Generator Cooldown.

## 2.2 Manufacturer

The controller shall be a Firetrol brand.

### **Firetrol, Inc.**

3412 Apex Peakway  
Apex, North Carolina 27502  
P +1 919 460 5200  
F +1 919 460 5250  
www.firetrol.com

While every precaution has been taken to ensure accuracy and completeness herein, Firetrol, Inc. assumes no responsibility, and disclaims all liability, for damages resulting from use of this information or for any errors or omissions. Specifications and drawings are subject to change without notice. ©2021 Firetrol, Inc., All Rights Reserved.

**Publication SP1300-61 Rev. C**



**Description**—Firetrol® FTA1300 Wye-Delta, Open Transition Starting Fire Pump Controllers are used with delta-wound squirrel cage motors. FTA1300 controllers are of the open circuit transition type in which the motor circuit is opened during the transition from start to run. The controller monitors, displays and records fire pump system information.

Actuating the controller by the pressure switch, START push-button or deluge valve contact closes the start contactor connecting the motor to the line in the wye connection. The motor will draw approximately 33% of its normal inrush current and develop approximately 33% of its normal starting torque. After a time delay, the motor is automatically reconnected in delta, applying full voltage to the motor windings. These controllers are recommended especially for use with generator sets.

Power Transfer Switches are completely assembled with Firetrol Electric Fire Pump Controllers; full or reduced voltage types. The power transfer switches are built for use with generator set or 2nd utility use. The entire package of power transfer switch and controller is completely factory assembled, wired, tested and shipped as a complete unit for easy field connection to the power sources and the fire pump motor.

**Approvals** – Firetrol fire pump controllers are listed by Underwriters’ Laboratories, Inc., in accordance with UL218, *Standard for Fire Pump Controllers*, CSA, *Standard for Industrial Control Equipment*, and approved by Factory Mutual. They are built to meet or exceed the requirements of the approving authorities as well as NEMA and the latest editions of NFPA 20, *Installation of Centrifugal Fire Pumps*, and NFPA 70, *National Electrical Code*.

The power transfer switches are listed by Underwriters’ Laboratories, Inc., in accordance with UL218, *Standard for Fire Pump Controllers*; UL1008, *Automatic Transfer Switches*; UL508, *Industrial Control Equipment*, CSA, *Standard for Industrial Control Equipment*, and approved by Factory Mutual. They are built to meet or exceed the requirements of the approving authorities as well as NEMA and the latest editions of NFPA 20, *Installation of Centrifugal Fire Pumps*, and NFPA 70, *National Electrical Code*.

**Controller Standard Features** – The following are included as standard with each controller:

- Voltage surge protector
- Main Disconnect Switch sized for connected motor horsepower and voltage
- Fire pump Circuit Breaker
- Single Handle Isolating Disconnect Switch/Circuit Breaker mechanism
- Motor contactor
- Single Handle Emergency Manual Run Mechanism to mechanically close motor contactor contacts in an emergency condition
- Built-in Start and Stop push-buttons to bypass automatic start circuits
- Daylight Savings Time Option
- Elapsed Time Meter

- 7.0" LCD capacitive type color touch screen (HMI technology) software upgradeable operator interface powered by an embedded microcomputer with software PLC logic.
- 500 PSI Pressure Transducer (calibrated for 300 PSI (20.7 Bar)) and Test Solenoid for fresh water applications, externally mounted with protective cover
- Audible alarm buzzer embedded in the MarkIII+
- Pump Room Ambient Temperature Switch, Display and Alarms
- Pressure and Event Recording with Date Stamp to System Memory Accessible VIA The User Interface and Downloadable to a USB Flash Drive
- Modbus Communications with TCP/IP frame format and a shielded female RJ45 connector
- NEMA Type 2 (IEC IP22) enclosure with bottom entry gland plate and lifting lugs
- Suitable for use as Service Equipment
- The controller supplies visual indication of the following: Power Available • Motor Run • Periodic Test • Manual Start • Deluge Valve Start • Remote Automatic Start • Remote Manual Start • Emergency Start • Pump On Demand (Automatic Start) • Pump Room Temp. • Lockout
- The controller displays visual indication for the following alarm conditions: Control Voltage Not Healthy • Invalid Cut-In • Lock Rotor Current • Loss of Power • Low Ambient Temp. • Low Water Level • Motor Trouble • Phase Reversal • Overcurrent • Overvoltage • Phase Loss L1 / L2 / L3 • Phase Unbalanced • Pressure Transducer Fault Detected • Pump On Demand • Pump Room Alarm • Service Required • Undercurrent • Undervoltage • Check Test Solenoid • Weekly Test Cut-In Reached
- Audible and Visible Indication for Fail To Start.
- DPDT 8A, 250VAC remote alarm contacts are provided for: Power Available • Phase Reversal • Motor Run • Common Pump Room Alarm (Overvoltage / Undervoltage / Phase Unbalance / Low Pump Room Temp. / High Pump Room Temp) • Common Motor Trouble (Overcurrent / Fail To Start / Undercurrent / Ground Fault)
- Field Adjustable Timers with Visual Countdown for Minimum Run (Off Delay), Sequential Start (On Delay) and Weekly Test

**Transfer Switch Standard Features** — The following are included as standard with each controller:

- Visual indication of the following: Alternate Power Lock Rotor Current • Alternate Power Phase Reversal • Automatic Transfer Switch Trouble
- Audible and Visible indication of: Alternate Power Circuit Breaker OFF or Tripped • Alternate Power Isolating Switch Tripped/Open
- Transfer Switch test push-button
- Bypass for re-transfer and generator shutdown
- The following adjustable time delays are provided: Momentary Normal Power Outage Override • Emergency Power Available Delay • Transfer Trouble Delay • Retransfer to Normal • Generator Cooldown
- Remote Alarm Contacts For: Emergency Isolating Switch Off • Transfer Switch in Normal Position • Transfer Switch in Emergency Position

FOR MODEL # INFORMATION SEE  
PUBLICATION SD1000-61  
FOR OPTIONS AND MODIFICATIONS SEE  
PUBLICATION OP1000-72

**Firetrol, Inc.**

3412 Apex Peakway  
Apex, North Carolina 27502  
P +1 919 460 5200  
F +1 919 460 5250  
www.firetrol.com

*While every precaution has been taken to ensure accuracy and completeness herein, Firetrol, Inc. assumes no responsibility, and disclaims all liability, for damages resulting from use of this information or for any errors or omissions. Specifications and drawings are subject to change without notice. ©2021 Firetrol, Inc., All Rights Reserved.*

Publication PD1300-61 Rev. C

MARK<sup>III</sup> Electric Fire Pump Controllers - Wye-Delta Open Transition Starting

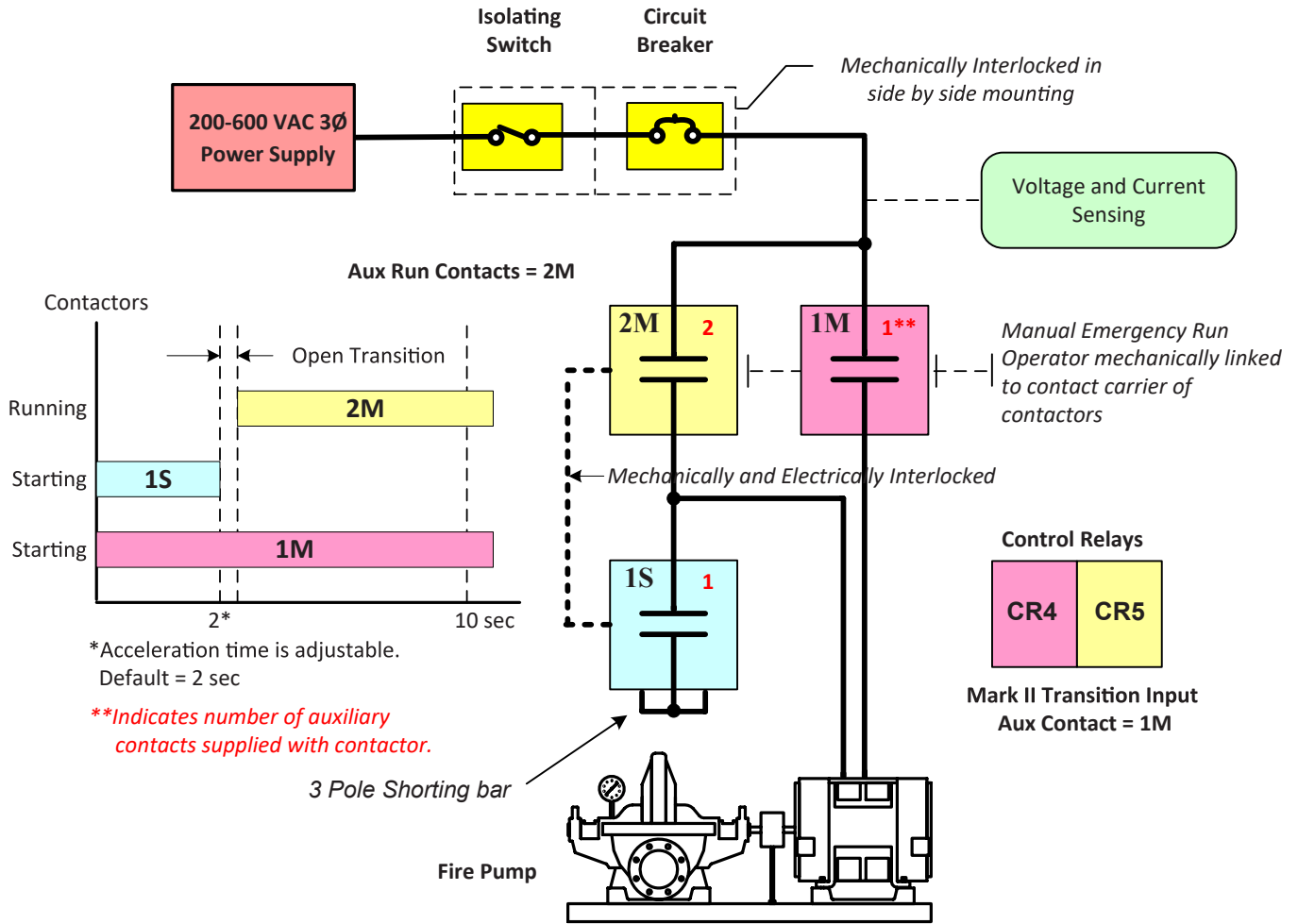

# General Starting Configuration

Wye-Delta starting (open transition)

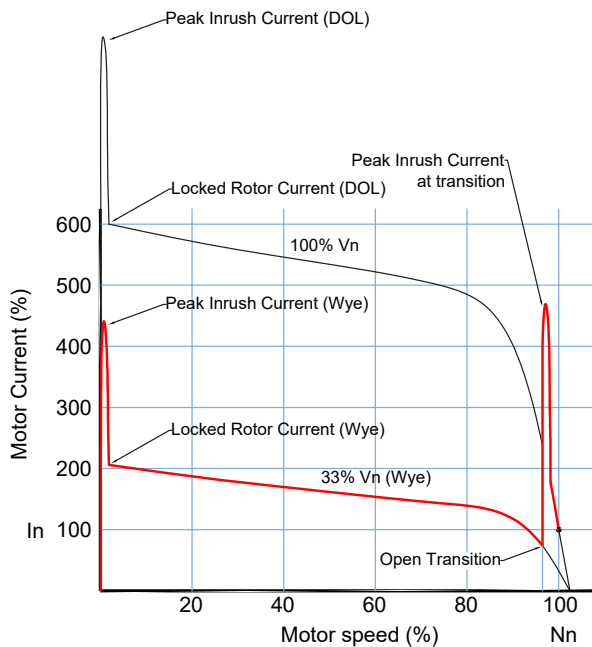

Legend:

FLA : Full Load Amperage / Full Load Current

FLT : Full-Load Torque / Rated Torque at FLA, Vn, and Full-Load Speed

Vn : Nominal Voltage / Rated Voltage

DOL : Direct On Line / Across-The-Line

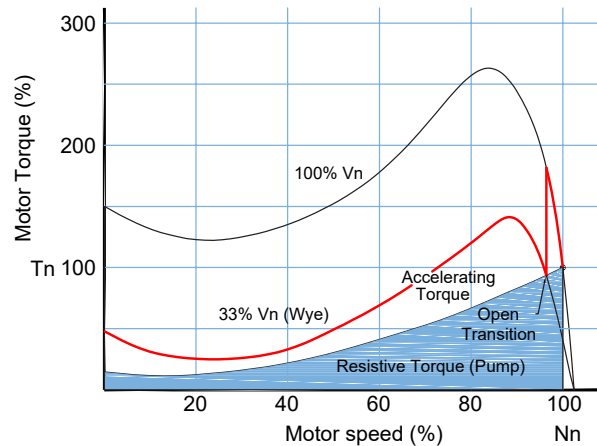

**Starting Method:** Wye-Delta open transition

**Starting voltage per winding:** Reduced

**Typical voltage applied at motor starting (%Vn):** 100%

**Peak inrush current at starting <sup>(1)</sup>:** 3.5 - 9 x FLA

**Peak inrush current at transition <sup>(1)</sup>:** 3.5 - 9 x FLA

**Starting current (% FLA) <sup>(2)</sup>:** 165 - 330%

**Transition current (% FLA) <sup>(3)</sup>:** 165 - 330%

**Starting Torque (% FLT) <sup>(4)</sup>:** 20 - 50%

**Motor type:** Standard Wye-Delta <sup>(5)</sup>

**Number of wire connections:** 6

- 1) A transient peak occurs when starting the motor while at rest or when disconnecting and reconnecting the motor during a transition. This transient lasts no more than 1/2 cycle.
- 2) The starting current (locked rotor current) is the Root Mean Square current value the motor takes from the power source at start and fades while the motor is accelerating to full speed. The larger the load on the motor, the slower the acceleration and the higher the current.
- 3) The transition current depends on the moment the transition occurs and the speed of the motor. A early transition will lead to increased current as the motor has not reached full speed for the load and voltage. A late transition suggests that the motor will be running at reduced voltage when the load is almost the same as full load. This causes the motor efficiency to drop and the temperature to rise in the motor stator windings. The motor can withstand this for a short period of time but it is not recommended to run the motor with reduced voltage for more than 5 seconds.
- 4) Generally, the torque developed by the induction motor at any speed is approximately proportional to the square of the voltage and inversely proportional to the square of the frequency. The locked rotor torque and breakdown torque are decreased when the voltage is unbalanced. If the voltage imbalance is severe, the torque may be inadequate for the application.
- 5) Induction motors are inherently capable of developing transient current and torque considerably in excess of rated current and torque when exposed to an out of phase bus transfer or momentary voltage interruption and re-closing on the same power supply. This transient torque can range from 2 to 20 times the rated torque and is related to many factors including: motor design, operating conditions, switching time, rotating system inertias and torsional spring constants, the number of motors on the bus and more.

This information is provided as a general information document. Consult an electrical engineer on your specific application.

## Firetrol, Inc.

3412 Apex Peakway  
Apex, North Carolina 27502  
P +1 919 460 5200  
F +1 919 460 5250  
www.firetrol.com

While every precaution has been taken to ensure accuracy and completeness herein, Firetrol, Inc. assumes no responsibility, and disclaims all liability, for damages resulting from use of this information or for any errors or omissions. Specifications and drawings are subject to change without notice. ©2021 Firetrol, Inc., All Rights Reserved.

Publication GS1300-10 Rev. B





MARK<sup>III+</sup> Electric Fire Pump Controllers with Power Transfer Switch

FTA1000, 1250, 1300, 1350, 1800, 1930  
ELECTRIC FIRE PUMP CONTROLLERS

Example: FTA1300-AM75HH-TSA-xx

**Starting Method**  
 1000 - Across-the-line (direct on line)  
 1250 - Part Winding (50%-50% windings)  
 1300 - Wye-delta (star-delta), open transition  
 1350 - Wye-delta (star-delta), closed transition  
 1800 - Autotransformer  
 1930 - Digital Solid-state soft start/stop

**Start/Stop Options**  
 A - Automatic/Manual start with manual stop only (default). Field configurable to automatic start with timed permissive stop after minimum run time and manual start with manual stop only.  
 C - For Manual only operation of Foam Controllers (use option -LK3)

**Modifications**  
 See Publication  
 OP1000-72

**Automatic Transfer Switch**

**Three Phase Voltage**  
 A - 220-240 Volt, 60 Hertz (230 V)  
 AZ - 220-230 Volt, 50 Hertz  
 B - 440-480 Volt, 60 Hertz (460 V)  
 BZ - 415 Volt, 50 Hertz  
 C - 550-600 Volt, 60 Hertz (575 V)  
 F - 380 Volt, 60 Hertz  
 FZ - 380 Volt, 50 Hertz  
 FF - 400 Volt, 60 Hertz  
 FX - 400 Volt, 50 Hertz  
 H - 208 Volt, 60 Hertz  
 HH - 200 Volt, 60 Hertz

Code	200-208V 5-150 HP	220-240V 5-200 HP	380-415V 5-350 HP	440-480V 5-400 HP	550-600V 5-500 HP
M - Standard	100kA	100kA	100kA	100kA	N/A
N - Intermediate	150kA	150kA	150kA	150kA	N/A
P - High	200kA	200kA	200kA	200kA	N/A
Q - Intermediate	N/A	N/A	N/A	N/A	100kA
R - Standard	N/A	N/A	N/A	N/A	50kA

Code	200-208V 200 HP	220-240V 250-400 HP	380-415V 400-500 HP	440-480V 450-500 HP
M - Standard	50A	50kA	50kA	50kA
N - Intermediate	N/A	N/A	N/A	N/A
P - High	100kA	100kA	100kA	100kA
Q - Intermediate	N/A	N/A	N/A	N/A
R - Standard	N/A	N/A	N/A	N/A

**Horsepower Rating**

03 - 3 HP	100 - 100 HP
05 - 5 HP	125 - 125 HP
07 - 7 1/2 HP	150 - 150 HP
10 - 10 HP	200 - 200 HP
15 - 15 HP	250 - 250 HP
20 - 20 HP	300 - 300 HP
25 - 25 HP	350 - 350 HP
30 - 30 HP	400 - 400 HP
40 - 40 HP	450 - 450 HP
50 - 50 HP	500 - 500 HP
60 - 60 HP	
75 - 75 HP	

For controller options and modifications see Publication OP10000-72.

**Firetrol, Inc.**

3412 Apex Peakway  
 Apex, North Carolina 27502  
 P +1 919 460 5200  
 F +1 919 460 5250  
 www.firetrol.com

While every precaution has been taken to ensure accuracy and completeness herein, Firetrol, Inc. assumes no responsibility, and disclaims all liability, for damages resulting from use of this information or for any errors or omissions. Specifications and drawings are subject to change without notice. ©2021 Firetrol, Inc., All Rights Reserved.



**MARK<sup>III+</sup> Electric Fire Pump Controllers**

**SPECIAL ENCLOSURES**

Option	Description
---	Enclosure, NEMA Type 2 (IEC IP22), Painted Steel (Standard)
-E	Enclosure, NEMA Type 4 (IEC IP65), Painted Steel
-F	Enclosure, NEMA Type 4X (IEC IP66), #304 Stainless Steel, Brushed Finish
-FD	Enclosure, NEMA Type 4X (IEC IP66), #316 Stainless Steel, Brushed Finish
-FDB	Enclosure, NEMA Type 4X (IEC IP66), #316 Stainless Steel, Seam Welded, Brushed Finish
-FDP	Enclosure, NEMA Type 4X (IEC IP66), #316 Stainless Steel, Painted Finish
-FXP	Enclosure, NEMA Type 4X (IEC IP66), #304 Stainless Steel, Painted Finish
-G	Enclosure, NEMA Type 12 (IEC IP54), Painted Steel
-T	Enclosure, NEMA Type 3R (IEC IP24), Painted Steel
-U	Enclosure, NEMA Type 3 (IEC IP54), Painted Steel

**CIRCUIT BREAKER OPTION**

Option	Description									
Standard Short Circuit Current Rating										
-M	200-208V	220-240V	380-415V	440-480V	550-600V	200-208V	220-240V	380-415V	440-480V	
-R	5-150 HP	5-200 HP	5-350 HP	5-400 HP	5-500 HP	200 HP	250-400 HP	400-500 HP	450-500 HP	
	100kA (M)	100kA (M)	100kA (M)	100kA (M)	50kA (R)	50kA (M)	50kA (M)	50kA (M)	50kA (M)	
Intermediate Short Circuit Current Rating										
-N	200-208V	220-240V	380-415V	440-480V	550-600V	200-208V	220-240V	380-415V	440-480V	
-Q	5-150 HP	5-200 HP	5-350 HP	5-400 HP	5-500 HP	200 HP	250-400 HP	400-500 HP	450-500 HP	
	150kA (N)	150kA (N)	150kA (N)	150kA (N)	100kA (Q)	N/A	N/A	N/A	N/A	
High Short Circuit Current Rating										
-P	200-208V	220-240V	380-415V	440-480V	550-600V	200-208V	220-240V	380-415V	440-480V	
	5-150 HP	5-200 HP	5-350 HP	5-400 HP	5-500 HP	200 HP	250-400 HP	400-500 HP	450-500 HP	
	200kA	200kA	200kA	200kA	NA	100kA	100kA	100kA	100kA	

**ANTI-CONDENSATION SPACE HEATERS**

Option	Description
None	
-J	Space Heater, 120V Externally Powered with Circuit Breaker & Thermostat
-K	Space Heater, 120V Externally Powered with Circuit Breaker & Humidistat
-M	Space Heater, 240V Externally Powered with Circuit Breaker & Thermostat
-N	Space Heater, 240V Externally Powered with Circuit Breaker & Humidistat
-JKP	Space Heater, 120V Externally Powered with Circuit Breaker, Thermostat and Humidistat in Parallel
-MNP	Space Heater, 240V Externally Powered with Circuit Breaker, Thermostat and Humidistat in Parallel

**PRESSURE TRANSDUCERS, SOLENOID VALVES, PLUMBING**

Option	Description
---	Wetted Parts including Pressure Sensor and Test Solenoid, 300 PSI (20.4 Bar) Fresh Water
-BI	Wetted Parts including Pressure Sensor and Test Solenoid, 500 PSI (34.5 Bar) Fresh Water (For Factory Calibration Purposes Only)
-C1	Wetted Parts including Pressure Sensor and Test Solenoid, 300 PSI (20.4 Bar), Sea Water
-D1	Wetted Parts including Pressure Sensor and Test Solenoid, 500 PSI (34.5 Bar), Sea Water
-SP1	Low Suction Pressure Transducer, Fresh Water, 0-300 PSI (20.4 Bar) with Visible Indication and Output Contacts
-SP2	Low Suction Pressure Transducer, Sea Water, 0-300 PSI (20.4 Bar) with Visible Indication and Output Contact

## FOAM PUMP APPLICATIONS

### Option

### Description

#### Required For Foam

- LR1 Low Foam Level External Input, Visible Indications and Alarm Contacts, Additive with Provisions for Proof Pressure Switch Connection, With Lockout and Remote Alarm Indication For Interlock On (Locked Out)

#### Required For Foam

- LK1 Foam Pump Application With Pressure Transducer and Run Test Solenoid Valve (Auto. Start)
- LK2 Foam Pump Application With Pressure Transducer and Run Test Solenoid Valve, Stainless Steel (Auto. Start)
- LK3 Foam Pump Application Without Pressure Transducer and Run Test Solenoid Valve (Manual Start)

#### Optional For Foam

- DVC Operation, Dump Valve Control

## ALARMS

### Option

### Description

- AC Extra Alarm Output Contacts, Pump Operating (2 Form-C)
- AM Alarm Output Contacts, Fail to Start
- AV Alarm Output Contacts, Low Pump Room Temperature
- AW Alarm Output Contacts, Reservoir Low
- AYI Configurable Low Suction Pressure, Visible/Output Contacts with External Digital Input
- BWI Extra Alarm Output Contacts, Phase Failure/Phase Reversal
- BYI Alarm Output Contacts, Overcurrent
- CTSI Configurable Low Suction Pressure, Visible/Output Contacts with Suction Pressure Transducer
- EHI Alarm Output Contacts, Main Relief Valve Open
- EK Alarm Output Contacts, Flow Meter Open
- JR Visible Indicator, Jockey Pump Operating
- JT Alarm, Audible/Visible, Jockey Pump Trouble
- KH Alarm Output Contacts, Common Alarm
- PI Alarm, Audible/Visible, Built-In 120V Supervisory System (Includes Visible Supervisory Voltage Normal Indication and Audible Pump Operating, Phase Failure and Phase Reversal Indication)
- PE Alarm Output Contacts, Low System Pressure (Pump on Demand)
- PT Alarm, Audible/Visible, Built-In 240V Supervisory System (Includes Visible Supervisory Voltage Normal Indication and Audible Pump Operating, Phase Failure and Phase Reversal Indication)

## MISCELLANEOUS

### Option

### Description

- ED2 Normal Source Load Shedding with Adjustable Time Delay to Remove Non-Critical Loads Before Starting
- EL Series Pumping Operation, High Zone Controller
- EM Series Pumping Operation, Mid Zone Controller
- EN Series Pumping Operation, Low Zone Controller
- IEC Marking, CE with External Wet Parts (Requires NEMA Type 12 (IP54) Enclosure as Minimum)
- MZN Neutral Lug, Service Entrance, Non-Insulated Bonded to Enclosure
- OSP Seismic Certification compliant to OSHPD (CA) for rigid base or wall mount only
- PK Terminal Blocks, Extra Remote Start
- PY Output Contacts, Motor Space Heater, Externally Powered
- S Tropicalization
- SEI Seismic Certification compliant to CBC 2019, IBC 2018 for rigid base or wall mount only
- USBX Data Port, External USB
- ZPMI Data Port, RS-485 Modbus RTU
- Y55 Controller Temperature Rating, 55°C (131°F) Ambient Temperature
- XCR Export Packaging (Wooden Crating to Conform to IPPC Standards)

## TRANSFER SWITCH ONLY OPTIONS

Option	Description
-EC	Extra Contacts for Remote Indication, Transfer Switch Position
-ED1	Alternate Source Load Shedding with Adjustable Time Delay to Remove Non-Critical Loads Before Starting

### **Firetrol, Inc.**

3412 Apex Peakway  
Apex, North Carolina 27502  
P +1 919 460 5200  
F +1 919 460 5250  
[www.firetrol.com](http://www.firetrol.com)

While every precaution has been taken to ensure accuracy and completeness herein, Firetrol, Inc. assumes no responsibility, and disclaims all liability, for damages resulting from use of this information or for any errors or omissions. Specifications and drawings are subject to change without notice. ©2022 Firetrol, Inc., All Rights Reserved.



© Firetrol, Inc. Not for construction.  
Subject to change without notice.

	BY	DD/MM/YY
DRAWN BY	ACD	07/02/23
FINAL APPROVAL	FC	23/02/23

## ELECTRIC FIRE PUMP CONTROLLER WITH AUTOMATIC TRANSFER SWITCH

**MODEL: FTA1000/FTA1250/FTA1300**

BUILT TO THE LATEST EDITION OF THE NFPA20 & NFPA70



THIRD ANGLE  
PROJECTION

DRAWING NUMBER	DD1000-841/E
DWG. REV. 0	
SHEET 1 OF 1	

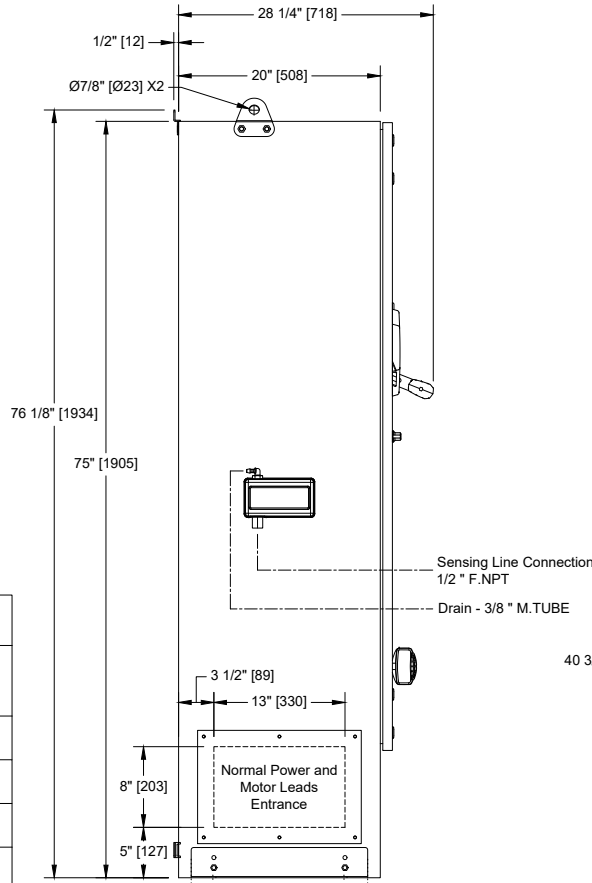

Voltage / Power Table		
Voltage	Min HP	Max HP
208	200	
220 - 240	250	
380 - 400 - 415	400	450
440 - 480	500	
600	Not Applicable	

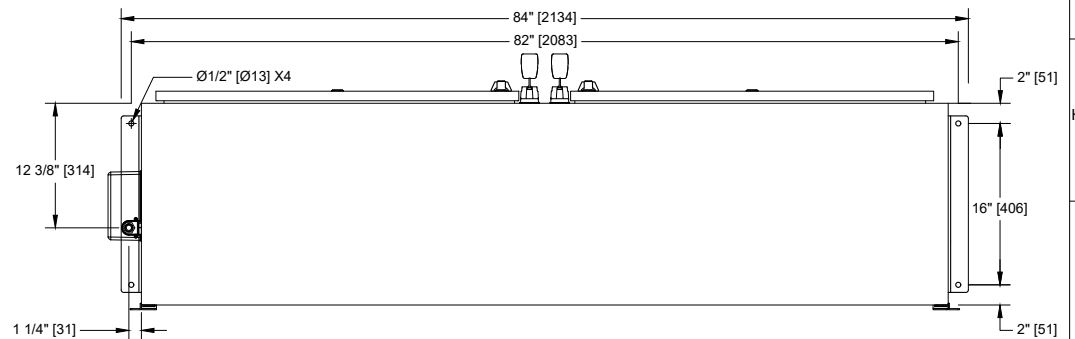
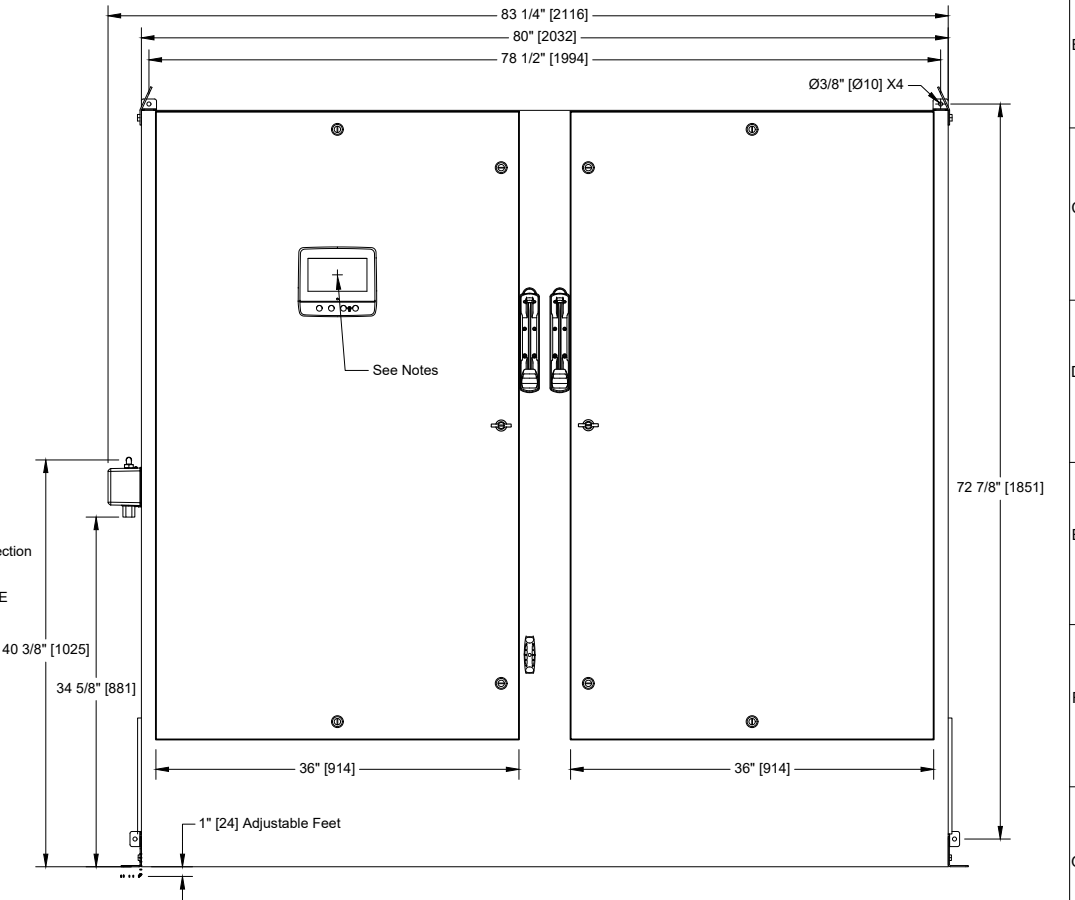

### Notes:

- Standard NEMA: NEMA 2
- Standard paint : textured red RAL 3002.
- All dimensions are in inches [millimeters].
- Center of the screen: 58-3/4" [1491] from bottom (no feet).
- Side conduit entrance through removable gland plate recommended.
- Use watertight conduit and connector only.
- Protect equipment against drilling chips.
- Door swing equal to door width.



© Firetrol, Inc. Not for construction.  
Subject to change without notice.

BY		DD/MM/YY
DRAWN BY	ACD	28/02/23
FINAL APPROVAL	FC	28/02/23

# ELECTRIC FIRE PUMP CONTROLLER REDUCED VOLTAGE / WYE DELTA (OPEN TRANSITION) WITH AUTOMATIC TRANSFER SWITCH

**MODEL: FTA1300**

BUILT TO THE LATEST EDITION OF THE NFPA20 & NFPA70



DRAWING NUMBER	WS1300-810/E
DWG REV. 0	
SHEET 1 OF 2	

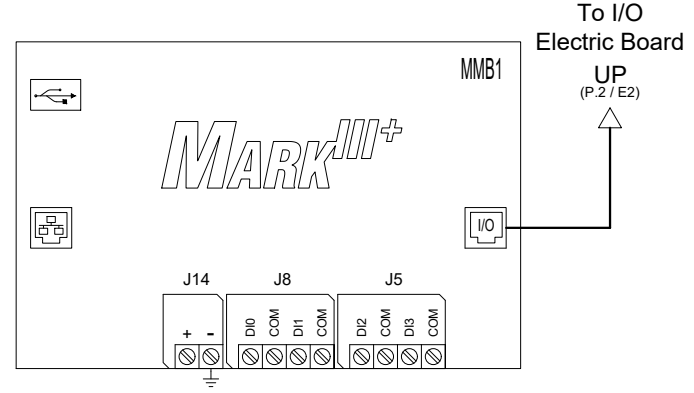
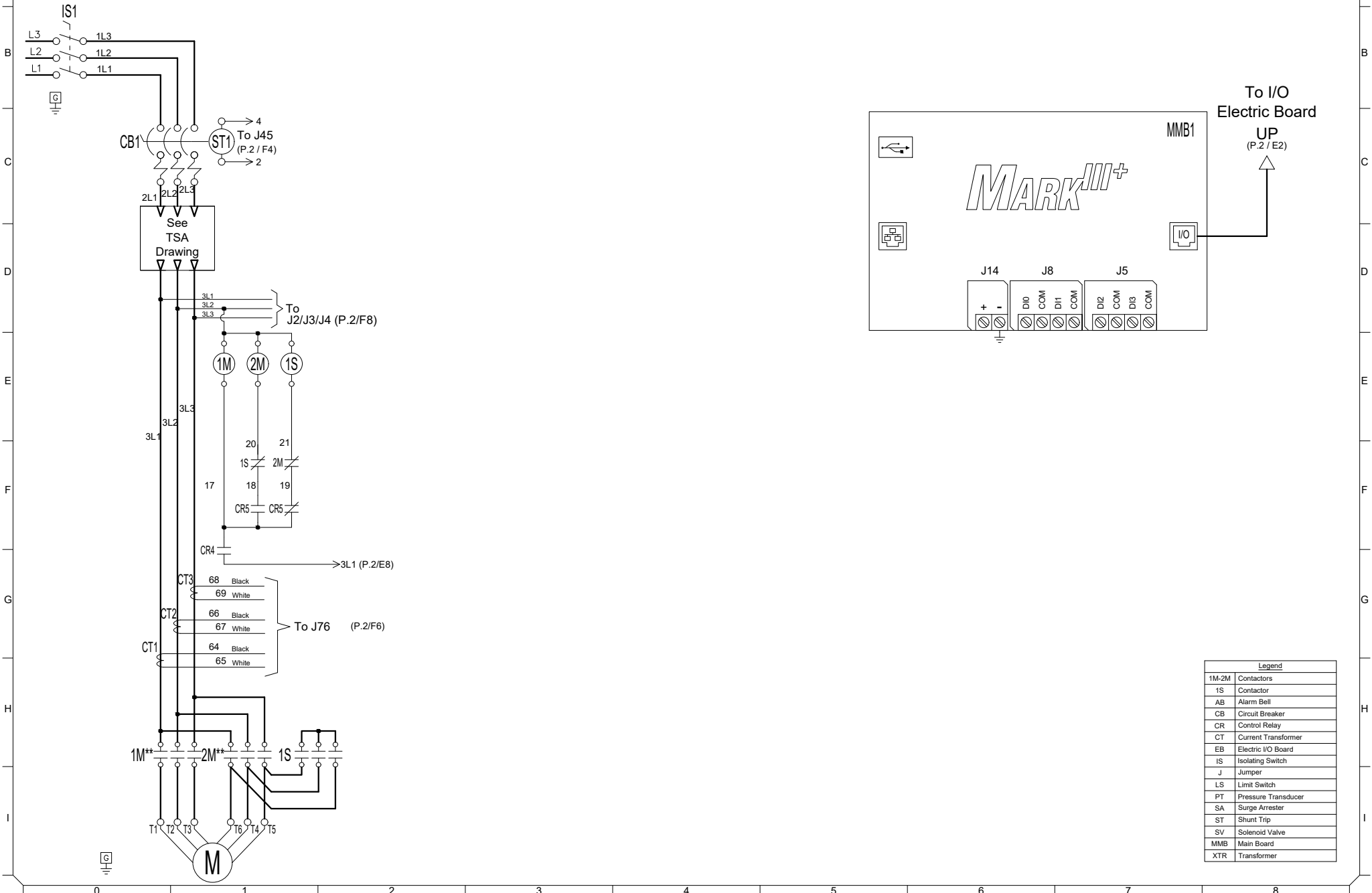

Legend	
1M-2M	Contactors
1S	Contactor
AB	Alarm Bell
CB	Circuit Breaker
CR	Control Relay
CT	Current Transformer
EB	Electric I/O Board
J	Jumper
LS	Limit Switch
PT	Pressure Transducer
SA	Surge Arrester
SV	Solenoid Valve
MMB	Main Board
XTR	Transformer



© Firetrol, Inc. Not for construction.  
Subject to change without notice.

BY		DD/MM/YY	
DRAWN BY	ACD	28/02/23	
FINAL APPROVAL	FC	28/02/23	

# ELECTRIC FIRE PUMP CONTROLLER REDUCED VOLTAGE / WYE DELTA (OPEN TRANSITION) WITH AUTOMATIC TRANSFER SWITCH

**MODEL: FTA1300**

BUILT TO THE LATEST EDITION OF THE NFPA20 & NFPA70



DRAWING NUMBER	WS1300-810/E
DWG REV. 0	
SHEET 2 OF 2	

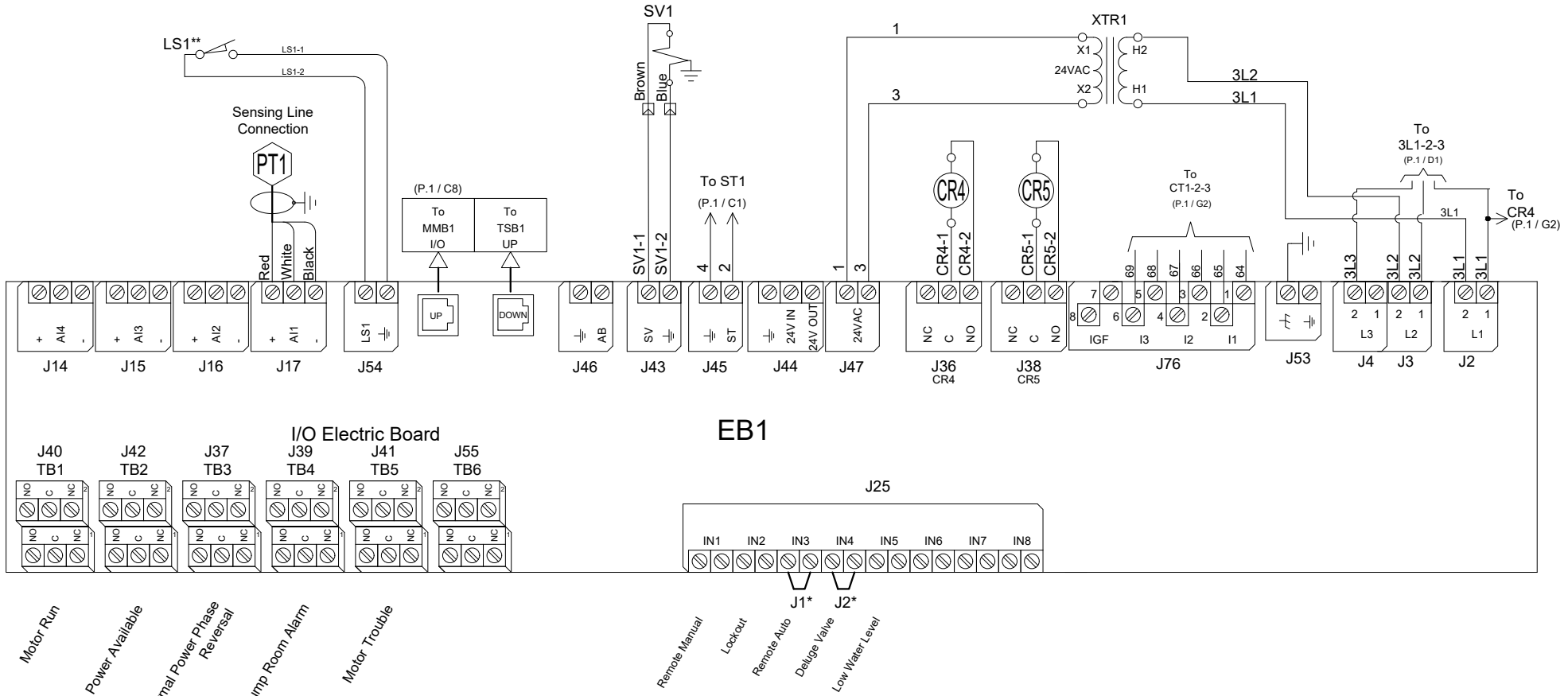

\* Remove jumper to use this feature  
\*\* Contact closes when emergency start is in "ON" position



© Firetrol, Inc. Not for construction.  
Subject to change without notice.

BY	DD/MM/YY
DRAWN BY	ACD 28/02/23
FINAL APPROVAL	FC 28/02/23

# AUTOMATIC TRANSFER SWITCH FOR ELECTRIC FIRE PUMP CONTROLLER

**MODEL: FTA950**

BUILT TO THE LATEST EDITION OF THE NFPA20 & NFPA70



DRAWING NUMBER	WS950-803 /E
DWG REV. 0	
SHEET 1 OF 1	

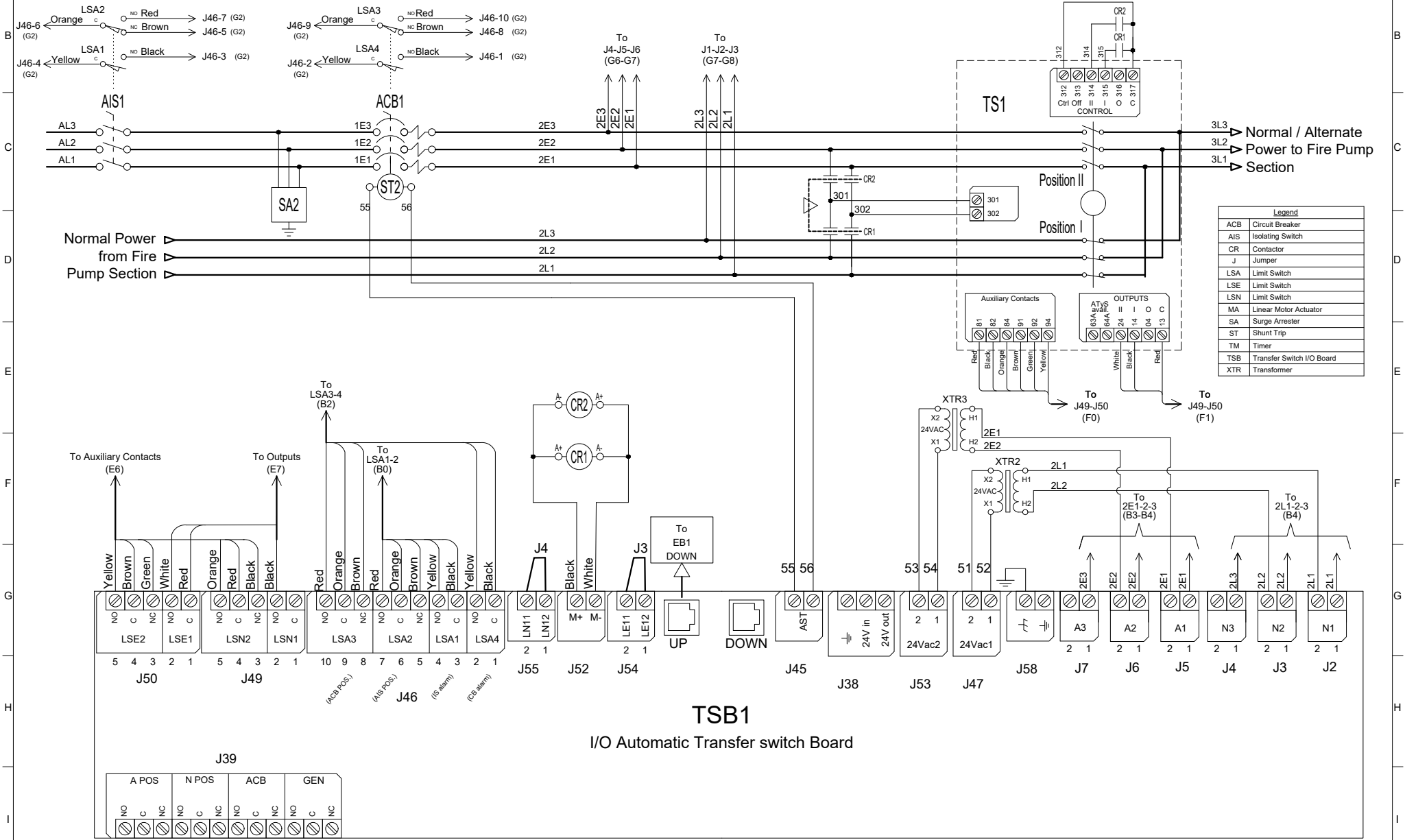

Legend	
ACB	Circuit Breaker
AIS	Isolating Switch
CR	Contactors
J	Jumper
LSA	Limit Switch
LSE	Limit Switch
LSN	Limit Switch
MA	Linear Motor Actuator
SA	Surge Arrester
ST	Shunt Trip
TM	Timer
TSB	Transfer Switch I/O Board
XTR	Transformer

**TSB1**  
I/O Automatic Transfer switch Board





© Firetrol, Inc. Not for construction.  
Subject to change without notice.

BY DD/MM/YY	
DRAWN BY	ACD 28/02/23
FINAL APPROVAL	FC 28/02/23

# ELECTRIC FIRE PUMP CONTROLLER

**MODEL: FTA1000**

BUILT TO THE LATEST EDITION OF THE NFPA20 & NFPA70



DRAWING NUMBER	FC1000-800 /E
DWG REV. 0	
SHEET 1 OF 1	

## COPPER CONDUCTORS for Isolating Switch (IS1).

Field Wiring According to Bending Space (AWG or MCM). Terminals L1 - L2 - L3

Bending Space	5" (127 mm)							8" (203 mm)			
	HP Voltage	5	7.5	10	15	20	25	30	40	50	60
208	1x (10 to 1/0)	1x (8 to 1/0)	1x (8 to 1/0)	1x (6 to 1/0)	1x (4 to 1/0)	1x (3 to 1/0)	1x (2 to 1/0)	1x (1 to 3/0)	1x (3/0 to 250)	1x (4/0 to 250)	
220 to 240	1x (10 to 1/0)	1x (10 to 1/0)	1x (8 to 1/0)	1x (6 to 1/0)	1x (4 to 1/0)	1x (4 to 1/0)	1x (3 to 1/0)	1x (1 to 3/0)	1x (2/0 to 3/0)	1x (3/0 to 250)	
380 to 416	1x (10 to 1/0)	1x (10 to 1/0)	1x (10 to 1/0)	1x (8 to 1/0)	1x (8 to 1/0)	1x (6 to 1/0)	1x (6 to 1/0)	1x (4 to 1/0)	1x (3 to 1/0)	1x (3 to 1/0)	
440 to 480	1x (10 to 1/0)	1x (10 to 1/0)	1x (10 to 1/0)	1x (10 to 1/0)	1x (8 to 1/0)	1x (8 to 1/0)	1x (6 to 1/0)	1x (6 to 1/0)	1x (4 to 1/0)	1x (3 to 1/0)	
600	1x (10 to 1/0)	1x (10 to 1/0)	1x (10 to 1/0)	1x (10 to 1/0)	1x (10 to 1/0)	1x (8 to 1/0)	1x (8 to 1/0)	1x (6 to 1/0)	1x (6 to 1/0)	1x (4 to 1/0)	

## Power Terminals

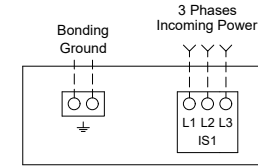

Bending Space	12" (305 mm)				16" (406 mm)							
	HP Voltage	75	100	125	150	200	250	300	350	400	450	500
208	2x (1/0 to 500)	2x (2/0 to 500)	2x (4/0 to 500)	2x (250 to 500)	3x (4/0 to 500)	-----	-----	-----	-----	-----	-----	-----
220 to 240	1x (250)	2x (2/0 to 500)	2x (3/0 to 500)	2x (4/0 to 500)	2x (350 to 500)	3x (250 to 500)	-----	-----	-----	-----	-----	-----
380 to 416	1x (1/0 to 3/0)	1x (3/0 to 250)	1x (250)	2x (1/0 to 500)	2x (3/0 to 500)	2x (4/0 to 500)	2x (300 to 500)	2x (400 to 500)	3x (250 to 500)	3x (300 to 500)	-----	-----
440 to 480	1x (1 to 3/0)	1x (2/0 to 3/0)	1x (3/0 to 250)	1x (4/0 to 250)	2x (1/0 to 500)	2x (3/0 to 500)	2x (4/0 to 500)	2x (300 to 500)	2x (350 to 500)	2x (400 to 500)	3x (250 to 500)	-----
600	1x (3 to 1/0)	1x (1 to 3/0)	1x (2/0 to 3/0)	1x (3/0 to 250)	1x (250)	2x (2/0 to 500)	2x (3/0 to 500)	2x (4/0 to 500)	2x (250 to 500)	2x (300 to 500)	2x (350 to 500)	-----
Bending Space	5" (127 mm)	8" (203 mm)				12" (305 mm)						

## ALUMINUM CONDUCTORS for Isolating Switch (IS1).

Field Wiring According to Bending Space (AWG or MCM). Terminals L1 - L2 - L3

Bending Space	5" (127 mm)							8" (203 mm)		10" (254 mm)	
	HP Voltage	5	7.5	10	15	20	25	30	40	50	60
208	1x (10 to 1/0)	1x (6 to 1/0)	1x (6 to 1/0)	1x (4 to 1/0)	1x (3 to 1/0)	1x (1 to 1/0)	1x (1/0)	1x (3/0)	1x (4/0 to 250)	1x (300)** or 1x (250) 90°C*	
220 to 240	1x (10 to 1/0)	1x (8 to 1/0)	1x (6 to 1/0)	1x (4 to 1/0)	1x (3 to 1/0)	1x (2 to 1/0)	1x (1 to 1/0)	1x (2/0 to 3/0)	1x (3/0) 90°C*	1x (250)	
380 to 416	1x (10 to 1/0)	1x (10 to 1/0)	1x (10 to 1/0)	1x (6 to 1/0)	1x (6 to 1/0)	1x (4 to 1/0)	1x (4 to 1/0)	1x (2 to 1/0)	1x (1 to 1/0)	1x (1/0)	
440 to 480	1x (10 to 1/0)	1x (10 to 1/0)	1x (10 to 1/0)	1x (8 to 1/0)	1x (6 to 1/0)	1x (6 to 1/0)	1x (6 to 1/0)	1x (4 to 1/0)	1x (2 to 1/0)	1x (1 to 1/0)	
600	1x (10 to 1/0)	1x (10 to 1/0)	1x (10 to 1/0)	1x (10 to 1/0)	1x (8 to 1/0)	1x (6 to 1/0)	1x (6 to 1/0)	1x (4 to 1/0)	1x (4 to 1/0)	1x (2 to 1/0)	

Bending Space	12" (305 mm)				16" (406 mm)							
	HP Voltage	75	100	125	150	200	250	300	350	400	450	500
208	2x (2/0 to 500)	2x (4/0 to 500)	2x (300 to 500)	2x (350 to 500)	3x (300 to 500)	-----	-----	-----	-----	-----	-----	-----
220 to 240	1x (350)**	2x (3/0 to 500)	2x (250 to 500)	2x (300 to 500)	2x (500)	3x (400 to 500)	-----	-----	-----	-----	-----	-----
380 to 416	N/A	1x (250 to 350)	1x (350)**	2x (3/0 to 500)	2x (4/0 to 500)	2x (300 to 500)	2x (500)	3x (300 to 500)**	3x (350 to 500)	3x (400 to 500)	-----	-----
440 to 480	1x (1/0 to 3/0)	1x (3/0)	N/A	1x (300 to 350)**	2x (3/0 to 500)	2x (250 to 500)	2x (300 to 500)	2x (400 to 500)	2x (500)	2x (500) 90°C*	3x (350 to 500)	-----
600	1x (1 to 1/0)	1x (2/0 to 3/0)	1x (3/0) 90°C*	1x (4/0 to 250)	1x (350 to 500)	2x (3/0 to 500)	2x (4/0 to 250)	2x (300 to 500)	2x (350 to 500)	2x (400 to 500)	2x (500)	-----
Bending Space	5" (127 mm)	8" (203 mm)				12" (305 mm)						

### Notes:

- 1 - For proper wire sizing, refer to NFPA70 and NEC (USA) or CEC (Canada) or local code.
- 2 - Controller suitable for service entrance in USA.
- 3 - For more accurate motor connections refer to motor manufacturer or motor nameplate.
- 4 - Controller is phase sensitive. Incoming lines must be connected in ABC sequence.

Drawing for information only.  
Manufacturer reserves the right to modify this drawing without notice.  
Contact manufacturer for "As Built" drawing.

\*For standard enclosure, use 90°C aluminium wire. Consult Factory for Use of Conductors Rated Lower than 90°C.

\*\* Consult Factory



© Firetrol, Inc. Not for construction.  
Subject to change without notice.

BY DD/MM/YY	
DRAWN BY	ACD 28/02/23
FINAL APPROVAL	FC 28/02/23

## AUTOMATIC TRANSFER SWITCH FOR ELECTRIC FIRE PUMP CONTROLLER

**MODEL: FTA950**

BUILT TO THE LATEST EDITION OF THE NFPA20 & NFPA70



DRAWING NUMBER	FC950-800 /E
DWG REV. 0	
SHEET 1 OF 1	

**COPPER CONDUCTORS** for Isolating Switch (AIS1).

Field Wiring According to Bending Space (AWG or MCM). Terminals AL1 - AL2 - AL3

Bending Space	5" (127 mm)							8" (203 mm)		
	HP Voltage	5	7.5	10	15	20	25	30	40	50
208	1x (10 to 1/0)	1x (8 to 1/0)	1x (8 to 1/0)	1x (6 to 1/0)	1x (4 to 1/0)	1x (3 to 1/0)	1x (2 to 1/0)	1x (1/0 to 3/0)	1x (3/0 to 250)	1x (4/0 to 250)
220 to 240	1x (10 to 1/0)	1x (10 to 1/0)	1x (8 to 1/0)	1x (6 to 1/0)	1x (4 to 1/0)	1x (4 to 1/0)	1x (3 to 1/0)	1x (1 to 3/0)	1x (2/0 to 3/0)	1x (3/0 to 250)
380 to 416	1x (10 to 1/0)	1x (10 to 1/0)	1x (10 to 1/0)	1x (8 to 1/0)	1x (8 to 1/0)	1x (6 to 1/0)	1x (6 to 1/0)	1x (4 to 1/0)	1x (3 to 1/0)	1x (3 to 1/0)
440 to 480	1x (10 to 1/0)	1x (10 to 1/0)	1x (10 to 1/0)	1x (10 to 1/0)	1x (8 to 1/0)	1x (8 to 1/0)	1x (6 to 1/0)	1x (6 to 1/0)	1x (4 to 1/0)	1x (3 to 1/0)
600	1x (10 to 1/0)	1x (10 to 1/0)	1x (10 to 1/0)	1x (10 to 1/0)	1x (10 to 1/0)	1x (8 to 1/0)	1x (8 to 1/0)	1x (6 to 1/0)	1x (6 to 1/0)	1x (4 to 1/0)

**Power Terminals**

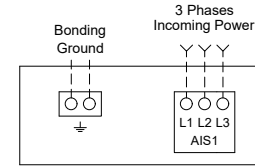

Bending Space	12" (305 mm)				16" (406 mm)							
	HP Voltage	75	100	125	150	200	250	300	350	400	450	500
208	2x (1/0 to 500)	2x (2/0 to 500)	2x (4/0 to 500)	2x (250 to 500)	3x (4/0 to 500)	-----	-----	-----	-----	-----	-----	-----
220 to 240	1x (250)	2x (2/0 to 500)	2x (3/0 to 500)	2x (4/0 to 500)	2x (350 to 500)	3x (250 to 500)	-----	-----	-----	-----	-----	-----
380 to 416	1x (1/0 to 3/0)	1x (3/0 to 250)	1x (250)	2x (1/0 to 500)	2x (3/0 to 500)	2x (4/0 to 500)	2x (300 to 500)	2x (400 to 500)	3x (250 to 500)	3x (300 to 500)	-----	-----
440 to 480	1x (1 to 3/0)	1x (2/0 to 3/0)	1x (3/0 to 250)	1x (4/0 to 250)	2x (1/0 to 500)	2x (3/0 to 500)	2x (4/0 to 500)	2x (300 to 500)	2x (350 to 500)	2x (400 to 500)	3x (250 to 500)	-----
600	1x (3 to 1/0)	1x (1 to 3/0)	1x (2/0 to 3/0)	1x (3/0 to 250)	1x (250)	2x (2/0 to 500)	2x (3/0 to 500)	2x (4/0 to 500)	2x (250 to 500)	2x (300 to 500)	2x (350 to 500)	-----
Bending Space	5" (127 mm)	8" (203 mm)				12" (305 mm)						

**ALUMINUM CONDUCTORS** for Isolating Switch (AIS1).

Field Wiring According to Bending Space (AWG or MCM). Terminals AL1 - AL2 - AL3

Bending Space	5" (127 mm)							8" (203 mm)		10" (254 mm)
	HP Voltage	5	7.5	10	15	20	25	30	40	50
208	1x (10 to 1/0)	1x (6 to 1/0)	1x (6 to 1/0)	1x (4 to 1/0)	1x (3 to 1/0)	1x (1 to 1/0)	1x (1/0)	1x (3/0)	1x (4/0 to 250)	1x (300)** or 1x (250) 90°C*
220 to 240	1x (10 to 1/0)	1x (8 to 1/0)	1x (6 to 1/0)	1x (4 to 1/0)	1x (3 to 1/0)	1x (2 to 1/0)	1x (1 to 1/0)	1x (2/0 to 3/0)	1x (3/0) 90°C*	1x (250)
380 to 416	1x (10 to 1/0)	1x (10 to 1/0)	1x (10 to 1/0)	1x (6 to 1/0)	1x (6 to 1/0)	1x (4 to 1/0)	1x (4 to 1/0)	1x (2 to 1/0)	1x (1 to 1/0)	1x (1/0)
440 to 480	1x (10 to 1/0)	1x (10 to 1/0)	1x (10 to 1/0)	1x (8 to 1/0)	1x (6 to 1/0)	1x (6 to 1/0)	1x (6 to 1/0)	1x (4 to 1/0)	1x (2 to 1/0)	1x (1 to 1/0)
600	1x (10 to 1/0)	1x (10 to 1/0)	1x (10 to 1/0)	1x (10 to 1/0)	1x (8 to 1/0)	1x (6 to 1/0)	1x (6 to 1/0)	1x (4 to 1/0)	1x (4 to 1/0)	1x (2 to 1/0)

Bending Space	12" (305 mm)				16" (406 mm)							
	HP Voltage	75	100	125	150	200	250	300	350	400	450	500
208	2x (2/0 to 500)	2x (4/0 to 500)	2x (300 to 500)	2x (350 to 500)	3x (300 to 500)	-----	-----	-----	-----	-----	-----	-----
220 to 240	1x (350)**	2x (3/0 to 500)	2x (250 to 500)	2x (300 to 500)	2x (500)	3x (400 to 500)	-----	-----	-----	-----	-----	-----
380 to 416	N/A	1x (250 to 350)	1x (350)**	2x (3/0 to 500)	2x (4/0 to 500)	2x (300 to 500)	2x (500)	3x (300 to 500)**	3x (350 to 500)	3x (400 to 500)	-----	-----
440 to 480	1x (1/0 to 3/0)	1x (3/0)	N/A	1x (300 to 350)**	2x (3/0 to 500)	2x (250 to 500)	2x (300 to 500)	2x (400 to 500)	2x (500)	2x (500) 90°C*	3x (350 to 500)	-----
600	1x (1 to 1/0)	1x (2/0 to 3/0)	1x (3/0) 90°C*	1x (4/0 to 250)	1x (350 to 500)	2x (3/0 to 500)	2x (4/0 to 250)	2x (300 to 500)	2x (350 to 500)	2x (400 to 500)	2x (500)	-----
Bending Space	5" (127 mm)	8" (203 mm)				12" (305 mm)						

\*For standard enclosure, use 90°C aluminium wire. Consult Factory for Use of Conductors Rated Lower than 90°C.

\*\* Consult Factory

Notes:  
1 - Controller is phase sensitive. Incoming lines must be connected in ABC sequence.

Drawing for information only.  
Manufacturer reserves the right to modify this drawing without notice.  
Contact manufacturer for "As Built" drawing.



© Firetrol, Inc. Not for construction.  
Subject to change without notice.

BY		DD/MM/YY
DRAWN BY	ACD	28/02/23
FINAL APPROVAL	FC	28/02/23

# ELECTRIC FIRE PUMP CONTROLLER

**MODEL: FTA1250/FTA1300/FTA1350**

BUILT TO THE LATEST EDITION OF THE NFPA20 & NFPA70



DRAWING NUMBER	FC1000-802 /E
DWG REV. 0	
SHEET 1 OF 1	

## COPPER CONDUCTORS for Motor Connection (1M-2M).

Field Wiring According to Bending Space (AWG or MCM). Terminals T1-T2-T3-T4-T5-T6-T7-T8-T9

HP Voltage	5	7.5	10	15	20	25	30	40	50	60
208	1x (10 to 4)	1x (10 to 4)	1x (10 to 4)	1x (8 to 4)	1x (8 to 4)	1x (6 to 4)	1x (6 to 4)	1x (4 to 2/0)	1x (2 to 2/0)	1x (1 to 2/0)
220 to 240	1x (10 to 4)	1x (10 to 4)	1x (10 to 4)	1x (8 to 4)	1x (8 to 4)	1x (6 to 4)	1x (6 to 4)	1x (4)	1x (3 to 2/0)	1x (2 to 2/0)
380 to 416	1x (10 to 4)	1x (10 to 4)	1x (10 to 4)	1x (10 to 4)	1x (10 to 4)	1x (10 to 4)	1x (8 to 4)	1x (8 to 4)	1x (6 to 4)	1x (4)
440 to 480	1x (10 to 4)	1x (10 to 4)	1x (10 to 4)	1x (10 to 4)	1x (10 to 4)	1x (10 to 4)	1x (10 to 4)	1x (8 to 4)	1x (8 to 4)	1x (6 to 4)
600	1x (10 to 4)	1x (10 to 4)	1x (10 to 4)	1x (10 to 4)	1x (10 to 4)	1x (10 to 4)	1x (10 to 4)	1x (10 to 4)	1x (8 to 4)	1x (8 to 4)

HP Voltage	75	100	125	150	200	250	300	350	400	450	500
208	1x (2/0 to 3/0)	1x (3/0 to 300)	1x (250 to 300)	2x (1/0 to 300)	2x (3/0 to 350)	-----	-----	-----	-----	-----	-----
220 to 240	1x (1/0 to 2/0)	1x (3/0)	1x (4/0 to 300)	1x (300)	2x (2/0 to 300)	2x (4/0 to 350)	-----	-----	-----	-----	-----
380 to 416	1x (4 to 2/0)	1x (2 to 2/0)	1x (1/0 to 2/0)	1x (2/0 to 3/0)	1x (4/0 to 300)	1x (300)	2x (2/0 to 300)	2x (3/0 to 300)	2x (4/0 to 350)	2x (4/0 to 350)	-----
440 to 480	1x (4)	1x (3 to 2/0)	1x (2 to 2/0)	1x (1/0 to 3/0)	1x (2/0 to 3/0)	1x (4/0 to 300)	1x (300)	2x (1/0 to 300)	2x (2/0 to 300)	2x (3/0 to 350)	2x (4/0 to 350)
600	1x (6 to 4)	1x (4)	1x (3 to 2/0)	1x (2 to 2/0)	1x (1/0 to 3/0)	1x (2/0 to 3/0)	1x (4/0 to 300)	1x (250 to 300)	1x (300)	2x (1/0 to 300)	2x (2/0 to 300)

## Motor Terminals

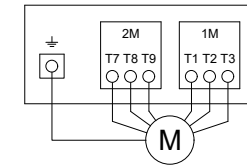

Model: FTA1250

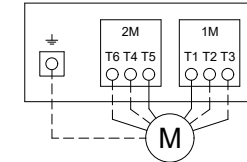

Models: FTA1300/FTA1350

## ALUMINUM CONDUCTORS for Contactor (1M-2M).

Field Wiring According to Bending Space (AWG or MCM). Terminals T1-T2-T3-T4-T5-T6-T7-T8-T9

HP Voltage	5	7.5	10	15	20	25	30	40	50	60
208	1x (12 to 2/0) **	1x (10 to 2/0) **	1x (10 to 2/0) **	1x (8 to 2/0) **	1x (6 to 2/0) **	1x (4 to 2/0) **	1x (4 to 2/0) **	1x (2 to 2/0)	1x (1/0 to 2/0)	1x (2/0)
220 to 240	1x (12 to 2/0) **	1x (10 to 2/0) **	1x (10 to 2/0) **	1x (8 to 2/0) **	1x (8 to 2/0) **	1x (6 to 2/0) **	1x (4 to 2/0) **	1x (2 to 2/0) **	1x (1 to 2/0)	1x (1/0 to 2/0)
380 to 416	1x (12 to 2/0) **	1x (12 to 2/0) **	1x (12 to 2/0) **	1x (10 to 2/0) **	1x (10 to 2/0) **	1x (8 to 2/0) **	1x (8 to 2/0) **	1x (6 to 2/0) **	1x (4 to 2/0) **	1x (3 to 2/0) **
440 to 480	1x (12 to 2/0) **	1x (12 to 2/0) **	1x (12 to 2/0) **	1x (12 to 2/0) **	1x (10 to 2/0) **	1x (10 to 2/0) **	1x (8 to 2/0) **	1x (8 to 2/0) **	1x (6 to 2/0) **	1x (4 to 2/0) **
600	1x (12 to 2/0) **	1x (12 to 2/0) **	1x (12 to 2/0) **	1x (12 to 2/0) **	1x (10 to 2/0) **	1x (10 to 2/0) **	1x (10 to 2/0) **	1x (8 to 2/0) **	1x (8 to 2/0) **	1x (6 to 2/0) **

HP Voltage	75	100	125	150	200	250	300	350	400	450	500
208	1x (3/0)	Consult Factory	1x (300) 90°C *	2x (3/0 to 300)	2x (250 to 350)	-----	-----	-----	-----	-----	-----
220 to 240	1x (2/0) 90°C *	Consult Factory	1x (300)	1x (300) 90°C *	2x (4/0 to 300)	2x (300 to 350)	-----	-----	-----	-----	-----
380 to 416	1x (2 to 2/0)	1x (1/0 to 2/0)	1x (1/0 to 2/0)	1x (3/0) 90°C *	1x (300)	1x (300) 90°C *	2x (4/0 to 300)	2x (250 to 300)	2x (300 to 350)	2x (300 to 350)	-----
440 to 480	1x (3 to 2/0) **	1x (2 to 2/0)	1x (2/0) 90°C *	1x (2/0 to 3/0)	1x (3/0) 90°C *	1x (300)	1x (300) 90°C *	2x (3/0 to 300)	2x (4/0 to 300)	2x (250 to 350)	2x (300 to 350)
600	1x (4 to 2/0) **	1x (3 to 2/0) **	1x (2 to 2/0)	1x (1/0 to 3/0)	1x (3/0)	1x (3/0) 90°C *	1x (300)	1x (300) 90°C *	Consult Factory	2x (3/0 to 300)	2x (4/0 to 300)

\*For standard enclosure, use 90°C aluminium wire. Consult Factory for Use of Conductors Rated Lower than 90°C.

\*\*Option V659 required.

### Notes:

- 1 - For proper wire sizing, refer to NFPA70 and NEC (USA) or CEC (Canada) or local code.
- 2 - Controller suitable for service entrance in USA.
- 3 - For more accurate motor connections refer to motor manufacturer or motor nameplate.
- 4 - Controller is phase sensitive. Incoming lines must be connected in ABC sequence.

Drawing for information only.  
Manufacturer reserves the right to modify this drawing without notice.  
Contact manufacturer for "As Built" drawing.



© Firetrol, Inc. Not for construction.  
Subject to change without notice.

BY		DD/MM/YY
DRAWN BY	ACD	28/02/23
FINAL APPROVAL	FC	28/02/23

# ELECTRIC FIRE PUMP CONTROLLER

## MODEL: FTA1000

BUILT TO THE LATEST EDITION OF THE NFPA20 & NFPA70



DRAWING NUMBER	FC1000-803 /E
DWG REV. 0	
SHEET 1 OF 1	

### Field Connections

Terminals Wire Size:  
24 - 12 AWG  
0.5 Nm

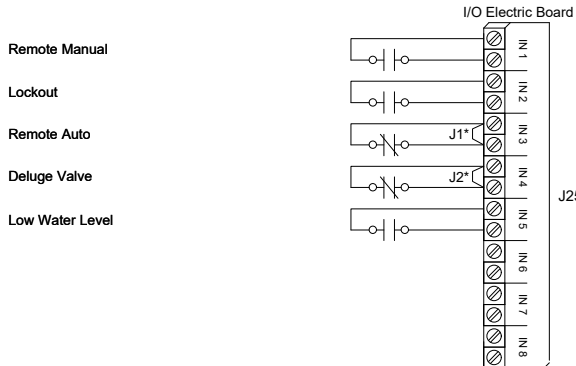

### Network Connections

Terminals Wire Size:  
Shielded Female Connector RJ45

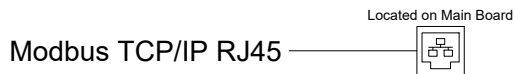

### Alarm Contacts

Terminals Wire Size:  
24 - 12 AWG  
0.5 Nm

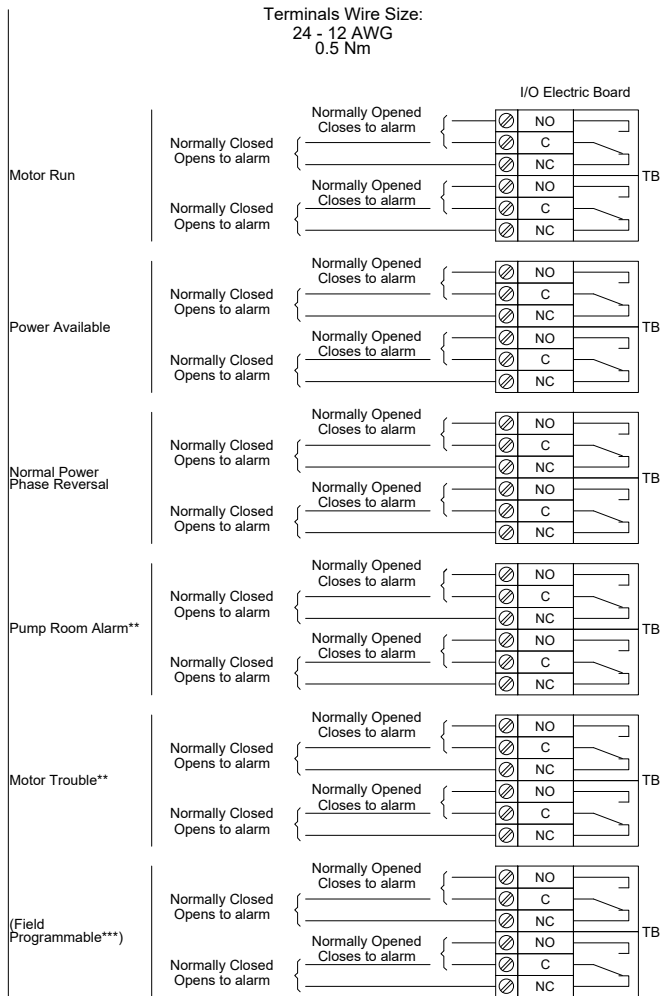

\* Remove jumper to use this feature  
 \*\* Re-assignable  
 \*\*\*\* Not available on Model FTA1930



© Firetrol, Inc. Not for construction.  
Subject to change without notice.

BY		DD/MM/YY
DRAWN BY	ACD	28/02/23
FINAL APPROVAL	FC	28/02/23

# AUTOMATIC TRANSFER SWITCH FOR ELECTRIC FIRE PUMP CONTROLLER

**MODEL: FTA950**

BUILT TO THE LATEST EDITION OF THE NFPA20 & NFPA70



DRAWING NUMBER	FC950-801 /E
DWG REV.	0
SHEET 1 OF 1	

## Remote Alarm Terminals (TSB1)

Terminals Wire Size:  
24 - 12 AWG  
0.5 Nm

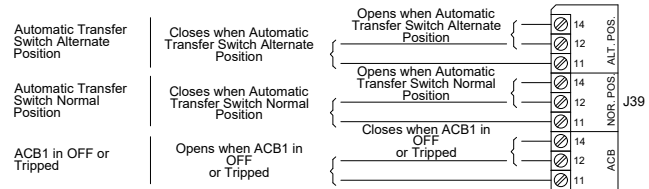

## Control Terminals (TSB1)

Terminals Wire Size:  
24 - 12 AWG  
0.5 Nm

