

MARK^{III+} Electric Fire Pump Controller - Wye-Delta Closed Transition Starting With Power Transfer Switch

Project Information

| Voltage / Power Table | | |
|-----------------------|--------|--------|
| Voltage | Min HP | Max HP |
| 380 - 400 - 415 | 150 | 200 |
| 440 - 480 | 200 | 250 |
| 600 | 250 | 350 |

DRAWINGS INCLUDED IN THIS PACKAGE ARE FOR STANDARD CONTROLLERS. ACTUAL "AS BUILT" DRAWINGS MAY DIFFER FROM THOSE SHOWN HERE.

Firetrol, Inc.

3362 Apex Peakway
Apex, North Carolina 27502
P +1 919 460 5200
F +1 919 460 5250
www.firetrol.com

While every precaution has been taken to ensure accuracy and completeness herein, Firetrol, Inc. assumes no responsibility, and disclaims all liability, for damages resulting from use of this information or for any errors or omissions. Specifications and drawings are subject to change without notice.
©2023 Firetrol, Inc., All Rights Reserved.

Firetrol MARK^{III+} Electric Fire Pump Controller

FTA1350/FTA950 – Wye-Delta Closed Transition Starting with Power Transfer Switch
Specifications

1.0 Main Fire Pump Controller

The main fire pump controller shall be a factory assembled, wired and tested unit. The controller shall be of the combined manual and automatic type designed for full voltage starting of the fire pump motor having the horsepower, voltage, phase and frequency rating shown on the plans and drawings. The controller shall be rated for an Ambient Temperature Operating Range of 39°F (4°C) to 104°F (40°C).

1.1 Standards, Listings & Approvals

The controller shall conform to all the requirements of the latest editions of:
NFPA 20, *Standard for the Installation of Stationary Pumps for Fire Protection*
NFPA 70, *National Electrical Code*.

The controller shall be listed by:

Underwriters Laboratories, Inc., in accordance with UL218, *Standard for Fire Pump Controllers* Canadian Standards Association CSA-C22.2, *Standard for Industrial Control Equipment (cUL)*
CE – Low Voltage Directive

The controller shall be approved by:

Factory Mutual (IEC 62091)

The City of New York for fire pump service

1.2 Enclosure

The controller components shall be housed in a NEMA Type 2 (IEC IP22) drip-proof, wall mounted enclosure.

1.3 Withstand Ratings (Short Circuit Current Ratings)

All controller components shall be front mounted, wired and front accessible for maintenance. The available short circuit current ratings are shown below. The ratings shall apply to the normal and emergency power components.

| | | | | | |
|------------------|----------------------|------------------------|------------------------|-----------------------|---------------------|
| Code | 200-208V 5-150 HP | 220-240V 5-200 HP | 380-415V 5-350 HP | 440-480 5-400 HP | 550-600 5-500 HP |
| M - Standard | 100kA | 100kA | 100kA | 100kA | N/A |
| N - Intermediate | 150kA | 150kA | 150kA | 150kA | N/A |
| P - High | 200kA | 200kA | 200kA | 200kA | N/A |
| Q - Intermediate | N/A | N/A | N/A | N/A | 100kA |
| R - Standard | N/A | N/A | N/A | N/A | 50kA |
| Code | 200-208V 200 HP | 220-240V 250-400 HP | 380-415V 400-500 HP | 440-480 450-500 HP | |
| M - Standard | 50A | 50kA | 50kA | 50kA | |
| N - Intermediate | N/A | N/A | N/A | N/A | |
| P - High | 100kA | 100kA | 100kA | 100kA | |
| Q - Intermediate | N/A | N/A | N/A | N/A | |
| R - Standard | N/A | N/A | N/A | N/A | |

1.4 Power Components

The controller shall include a combination isolating disconnect switch/circuit breaker, rated for not less than 115% of the motor full load current, mechanically interlocked and operated with a single, externally mounted handle. The isolating disconnect switch/circuit breaker shall be mechanically interlocked so that the enclosure door cannot be opened with the handle in the ON position except by a hidden tool operated bypass mechanism. The isolating disconnect switch/circuit breaker shall be capable of being

padlocked in the OFF position for installation and maintenance safety, and shall also be capable of being locked in the ON position without affecting the tripping characteristics of the circuit breaker.

The controller will include a voltage surge arrester and Wye-Delta Closed Transition motor starter.

The controller shall be equipped with a single handle, manually operated, emergency start mechanism capable of being latched in the ON position.

The controller shall include an Automatic Transfer Switch, electrically or manually operated, mechanically held.

1.5 Operator Interface (HMI)

The operator interface shall be a 7.0" LCD capacitive type color touch screen (HMI technology) powered by an embedded microcomputer with software PLC logic. Included shall be keypad type push-buttons for START, STOP, RUN TEST and TRANSFER SWITCH TEST.

The screen shall include menus for: *Home · Alarms · Configuration · History · Service · Manuals · Language.*

The HMI shall graphically display the following: *Voltage and Amperage of all 3 phases simultaneously using true RMS Technology for both the Normal and Alternate Power Sources · Transfer Switch Status · Motor Stopped/Running · Starting Cause · Actuation Mode · Controller Type · Shutdown Mode · Date & Time · Pump Room Temp. · System Pressure*

System pressure shall be capable of being displayed as: *PSI, kPa, Bar, Feet of Head or Meters of Water.*

The HMI shall allow programming and display of: *Cut In & Cut Out Pressure Settings · Minimum Run Timer · Sequential Start Timer · Periodic Test Timer*

The HMI allows the user to select the language of the system and download the manual or view the manual on screen.

1.6 State and Alarm Indication

Visual indication shall be provided for the following:

Power Available • Motor Run • Periodic Test • Manual Start • Deluge Valve Start • Remote Automatic Start • Remote Manual Start • Emergency Start • Pump On Demand/Automatic Start • Pump Room Temperature • Lockout

The digital display shall visually indicate the following alarms:

Alternate Power Lock Rotor Current • Alternate Power Phase Reversal • Automatic Power Transfer Switch Trouble • Locked Rotor Current • Fail To Start • Under/Over Current • Under/Over Voltage • Phase Unbalance • Check Test Solenoid Valve • Weekly Test Cut-In Not Reached • Transducer Fault • Control Voltage Not Healthy • Motor Trouble • Pump Room Alarm • Invalid Cut-In • Phase Reversal • Power Loss • Phase Loss L1 / L2 / L3 • Low Water Level • Pump On Demand • Low Ambient Temp. • Service Required

Audible and visible alarm shall be provided for:

Fail To Start • Alternate Circuit Breaker Off or Tripped • Alternate Isolating Switch Tripped/ Open •

Remote Alarm contacts shall be provided for:

Power Available • Phase Reversal • Motor Run • Common Pump Room Alarm (Overvoltage, Undervoltage, Phase Unbalance, Low/High Pump Room Temperature) • Common Motor Trouble (Overcurrent, Fail To Start, Undercurrent, Ground Fault) • Transfer Switch in Normal Position • Transfer Switch in Alternate Position • Alternate Power Isolating Switch Off

1.7 Pressure and Event Recording

The system shall be capable of logging pressure data and operational events with time/date stamp. The system shall display operational events for the lifetime of the controller and display the pressure data in text or graphical form. The controller shall log the Date/Time of the first start-up and the controller total power on time from that date. The controller shall log first and last statistics for: *First Setup · On Time · Start Count · Last Start Time · Min/Max/Average System Pressure · Min/Max/Average Pump Room Temp. · Jockey Pump On Time/Start Count/Last Start Time · Phase to Phase Voltages with Date Stamp · Amps Per Phase with Date Stamp*

1.8 USB Host Controller

A USB port capable of accepting a USB Flash Memory Disk shall be provided for downloading pressure and event logs.

1.9 Serial Communications

The controller shall feature Modbus with TCP/IP frame format and shielded female RJ45 connector

2.0 Pressure Sensing / Wet Parts

The controller shall be supplied with a solid state pressure transducer with a range of 0-500 psi calibrated for 0-300 psi (0-20.7 bar) and a run test solenoid valve. The wet parts shall be externally mounted and include a protective cover. The pressure sensing line connection to the transducer shall be 1/2-inch FNPT. Provisions for a redundant pressure transducer shall be provided.

2.1 Controller Operation

The controller shall be capable of automatic starting via pressure drop, remote start signal from an automatic device or a deluge valve. The controller can be manually started via the START push-button, the RUN TEST push-button, or a remote signal from a manual device. Stopping can be achieved manually with the STOP push-button or automatically after expiration of minimum run timer or test timer. The minimum run timer (off delay), sequential start timer (on delay) and periodic test timer shall be field adjustable and include a visual countdown on the display. Adjustable timers shall be supplied for Momentary Normal Power Outage Override, Alternate Power Available Delay, Transfer Trouble Delay, Retransfer To Normal, Generator Cooldown.

2.2 Manufacturer

The controller shall be a Firetrol brand.

Firetrol, Inc.

3412 Apex Peakway
Apex, North Carolina 27502
P +1 919 460 5200
F +1 919 460 5250
www.firetrol.com

While every precaution has been taken to ensure accuracy and completeness herein, Firetrol, Inc. assumes no responsibility, and disclaims all liability, for damages resulting from use of this information or for any errors or omissions. Specifications and drawings are subject to change without notice. ©2021 Firetrol, Inc., All Rights Reserved.



Description—Firetrol® FTA1350 Wye-Delta, Closed Transition Starting Fire Pump Controllers are used with delta-wound squirrel cage motors. FTA1350 controllers are of the closed circuit transition type in which the motor circuit remains closed during the transition from start to run. The controller monitors, displays and records fire pump system information. Actuating the controller via pressure, START push-button or deluge valve contact closes the start contactor connecting the motor to the line in the wye connection. The motor will draw approximately 33% of its normal inrush current and develop approximately 33% of its normal starting torque. After a time delay, the motor is automatically reconnected in delta, applying full voltage to the motor windings. During this transition, a resistor is connected to each phase, minimizing line disturbances and voltage drop during starting. These controllers are recommended especially for use with generator sets.

Power Transfer Switches are completely assembled with Firetrol Electric Fire Pump Controllers; full or reduced voltage types. The power transfer switches are built for use with generator set or 2nd utility use. The entire package of power transfer switch and controller is completely

factory assembled, wired, tested and shipped as a complete unit for easy field connection to the power sources and the fire pump motor.

Approvals – Firetrol fire pump controllers are listed by Underwriters’ Laboratories, Inc., in accordance with UL218, *Standard for Fire Pump Controllers*, CSA, *Standard for Industrial Control Equipment*, and approved by Factory Mutual. They are built to meet or exceed the requirements of the approving authorities as well as NEMA and the latest editions of NFPA 20, *Installation of Centrifugal Fire Pumps*, and NFPA 70, *National Electrical Code*.

The power transfer switches are listed by Underwriters’ Laboratories, Inc., in accordance with UL218, *Standard for Fire Pump Controllers*; UL1008, *Automatic Transfer Switches*; UL508, *Industrial Control Equipment*, CSA, *Standard for Industrial Control Equipment*, and approved by Factory Mutual. They are built to meet or exceed the requirements of the approving authorities as well as NEMA and the latest editions of NFPA 20, *Installation of Centrifugal Fire Pumps*, and NFPA 70, *National Electrical Code*.

Controller Standard Features — The following are included as standard with each controller:

- Voltage surge protector
- Main Disconnect Switch sized for connected motor horsepower and voltage
- Fire pump Circuit Breaker
- Single Handle Isolating Disconnect Switch/Circuit Breaker mechanism
- Motor contactor

- Single Handle Emergency Manual Run Mechanism to mechanically close motor contactor contacts in an emergency condition
- Built-in Start and Stop push-buttons to bypass automatic start circuits
- Daylight Savings Time Option
- Elapsed Time Meter
- 7.0" LCD capacitive type color touch screen (HMI technology) software upgradeable operator interface powered by an embedded microcomputer with software PLC logic.
- 500 PSI Pressure Transducer (calibrated for 300 PSI (20.7 Bar)) and Test Solenoid for fresh water applications, externally mounted with protective cover
- Audible alarm buzzer embedded in the MarkIII+
- Pump Room Ambient Temperature Switch, Display and Alarms
- Pressure and Event Recording with Date Stamp to System Memory Accessible VIA The User Interface and Downloadable to a USB Flash Drive
- Modbus Communications with TCP/IP frame format and a shielded female RJ45 connector
- NEMA Type 2 (IEC IP22) enclosure with bottom entry gland plate and lifting lugs
- Suitable for use as Service Equipment
- The controller supplies visual indication of the following: Power Available • Motor Run • Periodic Test • Manual Start • Deluge Valve Start • Remote Automatic Start • Remote Manual Start • Emergency Start • Pump On Demand (Automatic Start) • Pump Room Temp. • Lockout
- The controller displays visual indication for the following alarm conditions: Control Voltage Not Healthy • Invalid Cut-In • Lock Rotor Current • Loss of Power • Low Ambient Temp. • Low Water Level • Motor Trouble • Phase Reversal • Overcurrent • Overvoltage • Phase Loss L1 / L2 / L3 • Phase Unbalanced • Pressure Transducer Fault Detected • Pump On Demand • Pump Room Alarm
- Service Required • Undercurrent • Undervoltage • Check Test Solenoid • Weekly Test Cut-In Reached
- Audible and Visible Indication for Fail To Start.
- DPDT 8A, 250VAC remote alarm contacts are provided for: Power Available • Phase Reversal • Motor Run • Common Pump Room Alarm (Overvoltage / Undervoltage / Phase Unbalance / Low Pump Room Temp. / High Pump Room Temp) • Common Motor Trouble (Overcurrent / Fail To Start / Undercurrent / Ground Fault)
- Field Adjustable Timers with Visual Countdown for Minimum Run (Off Delay), Sequential Start (On Delay) and Weekly Test

Transfer Switch Standard Features — The following are included as standard with each controller:

- Visual indication of the following: Alternate Power Lock Rotor Current • Alternate Power Phase Reversal • Automatic Transfer Switch Trouble
- Audible and Visible indication of: Alternate Power Circuit Breaker OFF or Tripped • Alternate Power Isolating Switch Tripped/Open
- Transfer Switch test push-button
- Bypass for re-transfer and generator shutdown
- The following adjustable time delays are provided: Momentary Normal Power Outage Override • Emergency Power Available Delay • Transfer Trouble Delay • Re-transfer to Normal • Generator Cooldown
- Remote Alarm Contacts For: Emergency Isolating Switch Off • Transfer Switch in Normal Position • Transfer Switch in Emergency Position

FOR MODEL # INFORMATION SEE PUBLICATION SD1000-61

FOR OPTIONS AND MODIFICATIONS SEE PUBLICATION OP1000-72

Firetrol, Inc.

3412 Apex Peakway
Apex, North Carolina 27502
P +1 919 460 5200
F +1 919 460 5250
www.firetrol.com

While every precaution has been taken to ensure accuracy and completeness herein, Firetrol, Inc. assumes no responsibility, and disclaims all liability, for damages resulting from use of this information or for any errors or omissions. Specifications and drawings are subject to change without notice. ©2021 Firetrol, Inc., All Rights Reserved.

Publication PD1350-61 Rev. C

MARK^{III+} Electric Fire Pump Controllers - Wye-Delta Closed Transition Starting

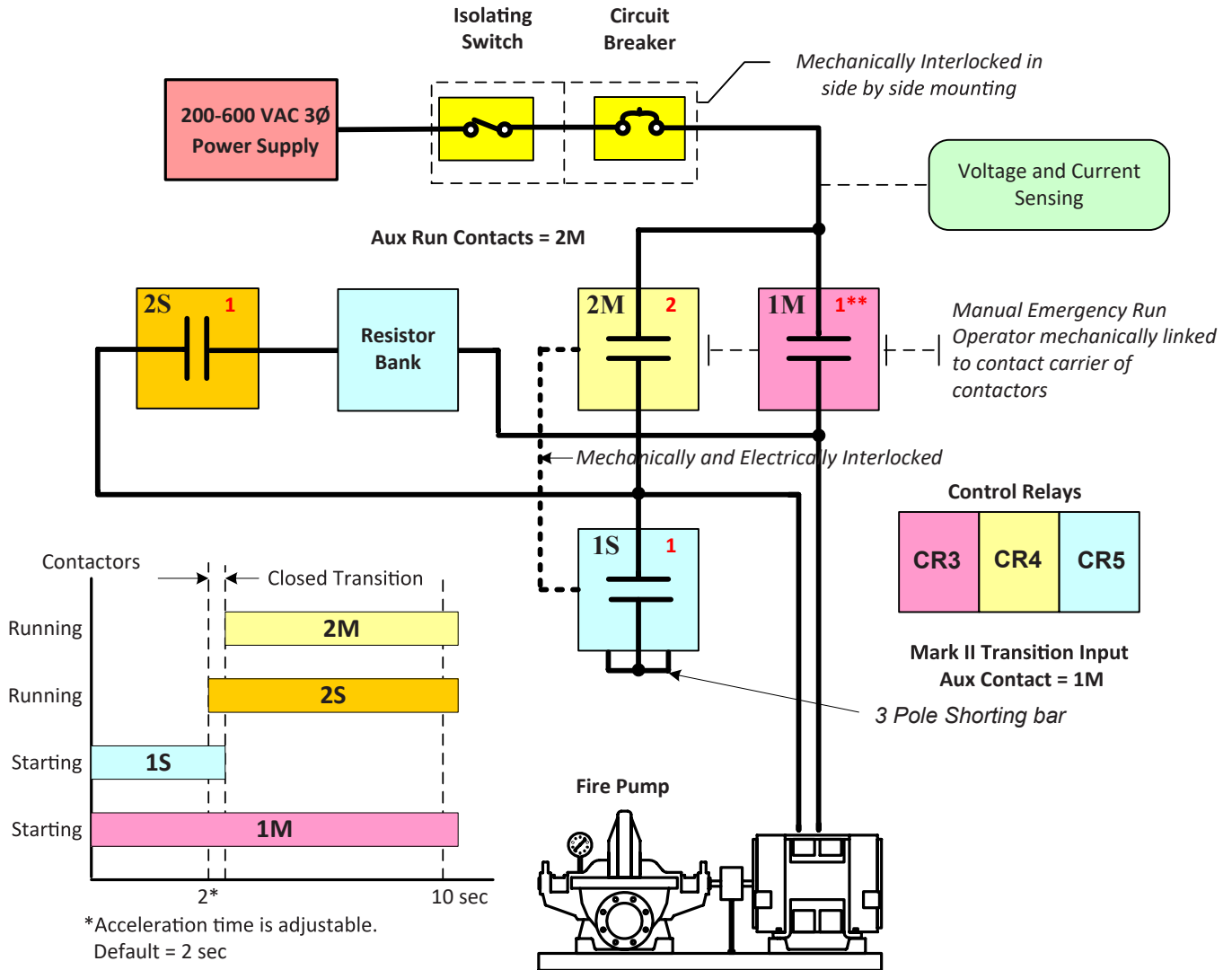

*Acceleration time is adjustable.
Default = 2 sec

**Indicates number of auxiliary contacts supplied with contactor.

General Starting Configuration

Wye-Delta starting (closed transition)

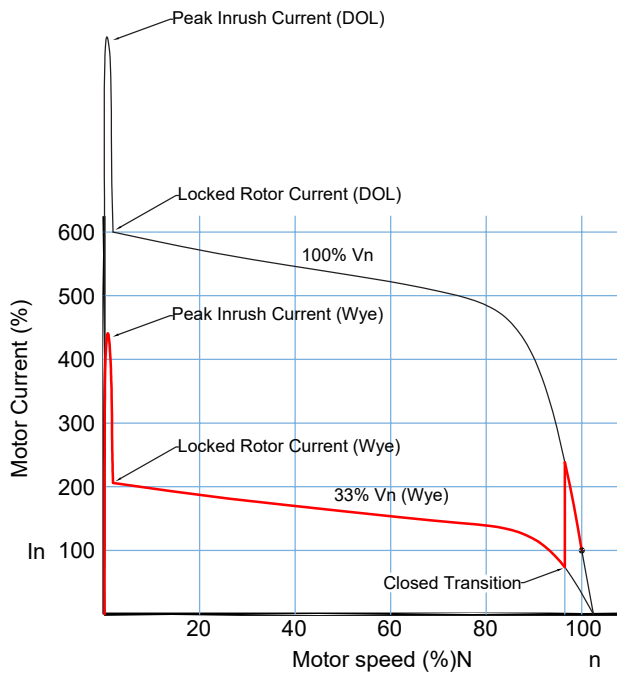

Legend:

FLA : Full Load Amperage / Full Load Current

FLT : Full-Load Torque / Rated Torque at FLA, V_n , and Full-Load Speed

V_n : Nominal Voltage / Rated Voltage

DOL : Direct On Line / Across-The-Line

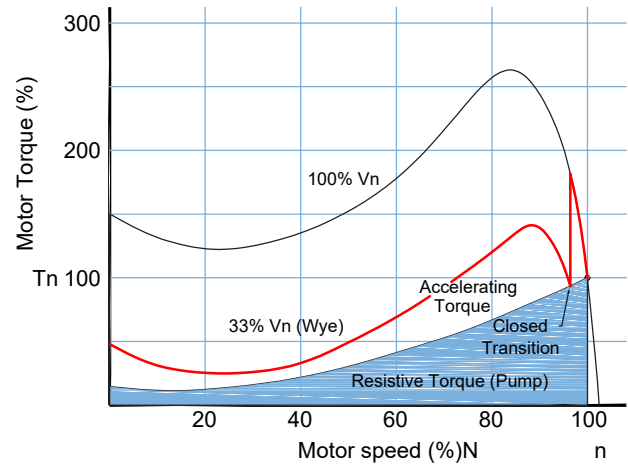

Starting Method: Wye-Delta closed transition

Starting voltage per winding: Reduced

Typical voltage applied at motor starting (% V_n): 100%

Peak inrush current at starting ⁽¹⁾: 3.5 - 9 x FLA

Peak inrush current at transition ⁽¹⁾: Negligible

Starting current (% FLA) ⁽²⁾: 165 - 330%

Transition current (% FLA) ⁽³⁾: 165 - 330%

Starting Torque (% FLT) ⁽⁴⁾: 20 - 50%

Motor type: Standard Wye-Delta

Number of wire connections: 6

- 1) A transient peak occurs when starting the motor while at rest or when disconnecting and reconnecting the motor during a transition. This transient lasts no more than 1/2 cycle.
- 2) The starting current (locked rotor current) is the Root Mean Square current value the motor takes from the power source at start and fades while the motor is accelerating to full speed. The larger the load on the motor, the slower the acceleration and the higher the current.
- 3) The transition current depends on the moment the transition occurs and the speed of the motor. A early transition will lead to increased current as the motor has not reached full speed for the load and voltage. A late transition suggests that the motor will be running at reduced voltage when the load is almost the same as full load. This causes the motor efficiency to drop and the temperature to rise in the motor stator windings. The motor can withstand this for a short period of time but it is not recommended to run the motor with reduced voltage for more than 5 seconds.
- 4) Generally, the torque developed by the induction motor at any speed is approximately proportional to the square of the voltage and inversely proportional to the square of the frequency. The locked rotor torque and breakdown torque are decreased when the voltage is unbalanced. If the voltage imbalance is severe, the torque may be inadequate for the application.
- 5) Induction motors are inherently capable of developing transient current and torque considerably in excess of rated current and torque when exposed to an out of phase bus transfer or momentary voltage interruption and re-closing on the same power supply. This transient torque can range from 2 to 20 times the rated torque and is related to many factors including: motor design, operating conditions, switching time, rotating system inertias and torsional spring constants, the number of motors on the bus and more.

This information is provided as a general information document. Consult an electrical engineer on your specific application.

Firetrol, Inc.

3412 Apex Peakway
Apex, North Carolina 27502
P +1 919 460 5200
F +1 919 460 5250
www.firetrol.com

While every precaution has been taken to ensure accuracy and completeness herein, Firetrol, Inc. assumes no responsibility, and disclaims all liability, for damages resulting from use of this information or for any errors or omissions. Specifications and drawings are subject to change without notice. ©2021 Firetrol, Inc., All Rights Reserved.



MARK^{III+} Electric Fire Pump Controllers with Power Transfer Switch

FTA1000, 1250, 1300, 1350, 1800, 1930
ELECTRIC FIRE PUMP CONTROLLERS

Example: FTA1300-AM75HH-TSA-xx

Starting Method
 1000 - Across-the-line (direct on line)
 1250 - Part Winding (50%-50% windings)
 1300 - Wye-delta (star-delta), open transition
 1350 - Wye-delta (star-delta), closed transition
 1800 - Autotransformer
 1930 - Digital Solid-state soft start/stop

Start/Stop Options
 A - Automatic/Manual start with manual stop only (default). Field configurable to automatic start with timed permissive stop after minimum run time and manual start with manual stop only.
 C - For Manual only operation of Foam Controllers (use option -LK3)

Modifications
 See Publication
 OP1000-72

Automatic Transfer Switch

Three Phase Voltage
 A - 220-240 Volt, 60 Hertz (230 V)
 AZ - 220-230 Volt, 50 Hertz
 B - 440-480 Volt, 60 Hertz (460 V)
 BZ - 415 Volt, 50 Hertz
 C - 550-600 Volt, 60 Hertz (575 V)
 F - 380 Volt, 60 Hertz
 FZ - 380 Volt, 50 Hertz
 FF - 400 Volt, 60 Hertz
 FX - 400 Volt, 50 Hertz
 H - 208 Volt, 60 Hertz
 HH - 200 Volt, 60 Hertz

| Code | 200-208V 5-150 HP | 220-240V 5-200 HP | 380-415V 5-350 HP | 440-480V 5-400 HP | 550-600V 5-500 HP |
|------------------|----------------------|----------------------|----------------------|----------------------|----------------------|
| M - Standard | 100kA | 100kA | 100kA | 100kA | N/A |
| N - Intermediate | 150kA | 150kA | 150kA | 150kA | N/A |
| P - High | 200kA | 200kA | 200kA | 200kA | N/A |
| Q - Intermediate | N/A | N/A | N/A | N/A | 100kA |
| R - Standard | N/A | N/A | N/A | N/A | 50kA |

| Code | 200-208V 200 HP | 220-240V 250-400 HP | 380-415V 400-500 HP | 440-480V 450-500 HP |
|------------------|--------------------|------------------------|------------------------|------------------------|
| M - Standard | 50A | 50kA | 50kA | 50kA |
| N - Intermediate | N/A | N/A | N/A | N/A |
| P - High | 100kA | 100kA | 100kA | 100kA |
| Q - Intermediate | N/A | N/A | N/A | N/A |
| R - Standard | N/A | N/A | N/A | N/A |

Horsepower Rating

| | |
|---------------|--------------|
| 03 - 3 HP | 100 - 100 HP |
| 05 - 5 HP | 125 - 125 HP |
| 07 - 7 1/2 HP | 150 - 150 HP |
| 10 - 10 HP | 200 - 200 HP |
| 15 - 15 HP | 250 - 250 HP |
| 20 - 20 HP | 300 - 300 HP |
| 25 - 25 HP | 350 - 350 HP |
| 30 - 30 HP | 400 - 400 HP |
| 40 - 40 HP | 450 - 450 HP |
| 50 - 50 HP | 500 - 500 HP |
| 60 - 60 HP | |
| 75 - 75 HP | |

For controller options and modifications see Publication OP10000-72.

Firetrol, Inc.

3412 Apex Peakway
 Apex, North Carolina 27502
 P +1 919 460 5200
 F +1 919 460 5250
 www.firetrol.com

While every precaution has been taken to ensure accuracy and completeness herein, Firetrol, Inc. assumes no responsibility, and disclaims all liability, for damages resulting from use of this information or for any errors or omissions. Specifications and drawings are subject to change without notice. ©2021 Firetrol, Inc., All Rights Reserved.



MARK^{III+} Electric Fire Pump Controllers

SPECIAL ENCLOSURES

| Option | Description |
|--------|---|
| --- | Enclosure, NEMA Type 2 (IEC IP22), Painted Steel (Standard) |
| -E | Enclosure, NEMA Type 4 (IEC IP65), Painted Steel |
| -F | Enclosure, NEMA Type 4X (IEC IP66), #304 Stainless Steel, Brushed Finish |
| -FD | Enclosure, NEMA Type 4X (IEC IP66), #316 Stainless Steel, Brushed Finish |
| -FDB | Enclosure, NEMA Type 4X (IEC IP66), #316 Stainless Steel, Seam Welded, Brushed Finish |
| -FDP | Enclosure, NEMA Type 4X (IEC IP66), #316 Stainless Steel, Painted Finish |
| -FXP | Enclosure, NEMA Type 4X (IEC IP66), #304 Stainless Steel, Painted Finish |
| -G | Enclosure, NEMA Type 12 (IEC IP54), Painted Steel |
| -T | Enclosure, NEMA Type 3R (IEC IP24), Painted Steel |
| -U | Enclosure, NEMA Type 3 (IEC IP54), Painted Steel |

CIRCUIT BREAKER OPTION

| Option | Description | | | | | | | | | |
|---|-------------|-----------|-----------|-----------|-----------|----------|------------|------------|------------|--|
| Standard Short Circuit Current Rating | | | | | | | | | | |
| -M | 200-208V | 220-240V | 380-415V | 440-480V | 550-600V | 200-208V | 220-240V | 380-415V | 440-480V | |
| -R | 5-150 HP | 5-200 HP | 5-350 HP | 5-400 HP | 5-500 HP | 200 HP | 250-400 HP | 400-500 HP | 450-500 HP | |
| | 100kA (M) | 100kA (M) | 100kA (M) | 100kA (M) | 50kA (R) | 50kA (M) | 50kA (M) | 50kA (M) | 50kA (M) | |
| Intermediate Short Circuit Current Rating | | | | | | | | | | |
| -N | 200-208V | 220-240V | 380-415V | 440-480V | 550-600V | 200-208V | 220-240V | 380-415V | 440-480V | |
| -Q | 5-150 HP | 5-200 HP | 5-350 HP | 5-400 HP | 5-500 HP | 200 HP | 250-400 HP | 400-500 HP | 450-500 HP | |
| | 150kA (N) | 150kA (N) | 150kA (N) | 150kA (N) | 100kA (Q) | N/A | N/A | N/A | N/A | |
| High Short Circuit Current Rating | | | | | | | | | | |
| -P | 200-208V | 220-240V | 380-415V | 440-480V | 550-600V | 200-208V | 220-240V | 380-415V | 440-480V | |
| | 5-150 HP | 5-200 HP | 5-350 HP | 5-400 HP | 5-500 HP | 200 HP | 250-400 HP | 400-500 HP | 450-500 HP | |
| | 200kA | 200kA | 200kA | 200kA | NA | 100kA | 100kA | 100kA | 100kA | |

ANTI-CONDENSATION SPACE HEATERS

| Option | Description |
|--------|---|
| None | |
| -J | Space Heater, 120V Externally Powered with Circuit Breaker & Thermostat |
| -K | Space Heater, 120V Externally Powered with Circuit Breaker & Humidistat |
| -M | Space Heater, 240V Externally Powered with Circuit Breaker & Thermostat |
| -N | Space Heater, 240V Externally Powered with Circuit Breaker & Humidistat |
| -JKP | Space Heater, 120V Externally Powered with Circuit Breaker, Thermostat and Humidistat in Parallel |
| -MNP | Space Heater, 240V Externally Powered with Circuit Breaker, Thermostat and Humidistat in Parallel |

PRESSURE TRANSDUCERS, SOLENOID VALVES, PLUMBING

| Option | Description |
|--------|--|
| --- | Wetted Parts including Pressure Sensor and Test Solenoid, 300 PSI (20.4 Bar) Fresh Water |
| -BI | Wetted Parts including Pressure Sensor and Test Solenoid, 500 PSI (34.5 Bar) Fresh Water (For Factory Calibration Purposes Only) |
| -C1 | Wetted Parts including Pressure Sensor and Test Solenoid, 300 PSI (20.4 Bar), Sea Water |
| -D1 | Wetted Parts including Pressure Sensor and Test Solenoid, 500 PSI (34.5 Bar), Sea Water |
| -SP1 | Low Suction Pressure Transducer, Fresh Water, 0-300 PSI (20.4 Bar) with Visible Indication and Output Contacts |
| -SP2 | Low Suction Pressure Transducer, Sea Water, 0-300 PSI (20.4 Bar) with Visible Indication and Output Contact |

FOAM PUMP APPLICATIONS

Option

Description

Required For Foam

- LR1 Low Foam Level External Input, Visible Indications and Alarm Contacts, Additive with Provisions for Proof Pressure Switch Connection, With Lockout and Remote Alarm Indication For Interlock On (Locked Out)

Required For Foam

- LK1 Foam Pump Application With Pressure Transducer and Run Test Solenoid Valve (Auto. Start)
- LK2 Foam Pump Application With Pressure Transducer and Run Test Solenoid Valve, Stainless Steel (Auto. Start)
- LK3 Foam Pump Application Without Pressure Transducer and Run Test Solenoid Valve (Manual Start)

Optional For Foam

- DVC Operation, Dump Valve Control

ALARMS

Option

Description

- AC Extra Alarm Output Contacts, Pump Operating (2 Form-C)
- AM Alarm Output Contacts, Fail to Start
- AV Alarm Output Contacts, Low Pump Room Temperature
- AW Alarm Output Contacts, Reservoir Low
- AYI Configurable Low Suction Pressure, Visible/Output Contacts with External Digital Input
- BWI Extra Alarm Output Contacts, Phase Failure/Phase Reversal
- BYI Alarm Output Contacts, Overcurrent
- CTSI Configurable Low Suction Pressure, Visible/Output Contacts with Suction Pressure Transducer
- EHI Alarm Output Contacts, Main Relief Valve Open
- EK Alarm Output Contacts, Flow Meter Open
- JR Visible Indicator, Jockey Pump Operating
- JT Alarm, Audible/Visible, Jockey Pump Trouble
- KH Alarm Output Contacts, Common Alarm
- PI Alarm, Audible/Visible, Built-In 120V Supervisory System (Includes Visible Supervisory Voltage Normal Indication and Audible Pump Operating, Phase Failure and Phase Reversal Indication)
- PE Alarm Output Contacts, Low System Pressure (Pump on Demand)
- PT Alarm, Audible/Visible, Built-In 240V Supervisory System (Includes Visible Supervisory Voltage Normal Indication and Audible Pump Operating, Phase Failure and Phase Reversal Indication)

MISCELLANEOUS

Option

Description

- ED2 Normal Source Load Shedding with Adjustable Time Delay to Remove Non-Critical Loads Before Starting
- EL Series Pumping Operation, High Zone Controller
- EM Series Pumping Operation, Mid Zone Controller
- EN Series Pumping Operation, Low Zone Controller
- IEC Marking, CE with External Wet Parts (Requires NEMA Type 12 (IP54) Enclosure as Minimum)
- MZN Neutral Lug, Service Entrance, Non-Insulated Bonded to Enclosure
- OSP Seismic Certification compliant to OSHPD (CA) for rigid base or wall mount only
- PK Terminal Blocks, Extra Remote Start
- PY Output Contacts, Motor Space Heater, Externally Powered
- S Tropicalization
- SEI Seismic Certification compliant to CBC 2019, IBC 2018 for rigid base or wall mount only
- USBX Data Port, External USB
- ZPMI Data Port, RS-485 Modbus RTU
- Y55 Controller Temperature Rating, 55°C (131°F) Ambient Temperature
- XCR Export Packaging (Wooden Crating to Conform to IPPC Standards)

TRANSFER SWITCH ONLY OPTIONS

| Option | Description |
|--------|--|
| -EC | Extra Contacts for Remote Indication, Transfer Switch Position |
| -ED1 | Alternate Source Load Shedding with Adjustable Time Delay to Remove Non-Critical Loads Before Starting |

Firetrol, Inc.

3412 Apex Peakway
Apex, North Carolina 27502
P +1 919 460 5200
F +1 919 460 5250
www.firetrol.com

While every precaution has been taken to ensure accuracy and completeness herein, Firetrol, Inc. assumes no responsibility, and disclaims all liability, for damages resulting from use of this information or for any errors or omissions. Specifications and drawings are subject to change without notice. ©2022 Firetrol, Inc., All Rights Reserved.



© Firetrol, Inc. Not for construction.
Subject to change without notice.

| | | |
|----------------|-----|----------|
| BY | | DD/MM/YY |
| DRAWN BY | DDS | 22/02/23 |
| FINAL APPROVAL | FC | 23/02/23 |

ELECTRIC FIRE PUMP CONTROLLER WITH AUTOMATIC TRANSFER SWITCH

MODEL: FTA1350/FTA1800/FTA1930

BUILT TO THE LATEST EDITION OF THE NFPA20 & NFPA70



DRAWING NUMBER
DD1000-833/E
DWG REV. 0
SHEET 1 OF 1

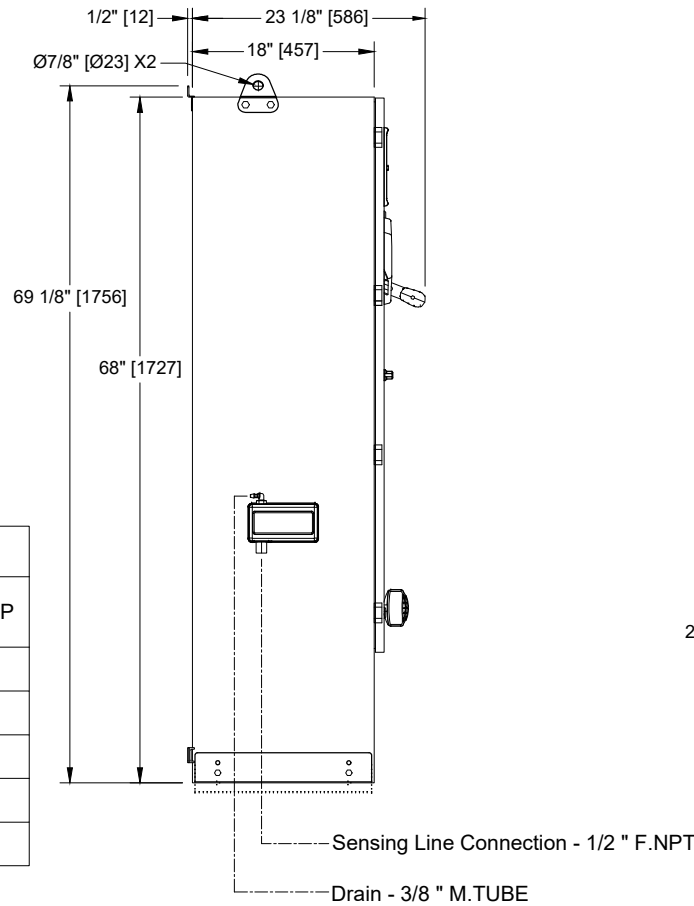

| Voltage / Power Table | | |
|-----------------------|--------|--------|
| Voltage | Min HP | Max HP |
| 208 | 75 | 125 |
| 220 - 240 | 100 | 125 |
| 380 - 400 - 415 | 150 | 200 |
| 440 - 480 | 200 | 250 |
| 600 | 250 | 350 |

Notes:

- Standard NEMA: NEMA 2
- Standard paint : textured red RAL 3002.
- All dimensions are in inches [millimeters].
- Center of screen: 61-5/8" [1564] from bottom.
- Bottom conduit entrance through removable gland plate recommended.
- Use watertight conduit and connector only.
- Protect equipment against drilling chips.
- Door swing equal to door width.

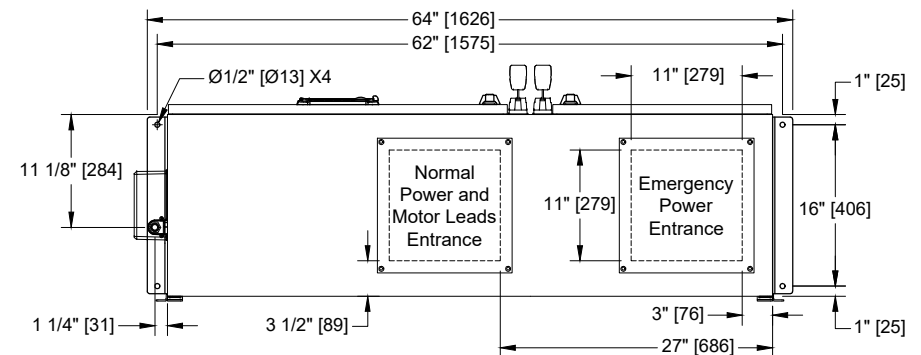
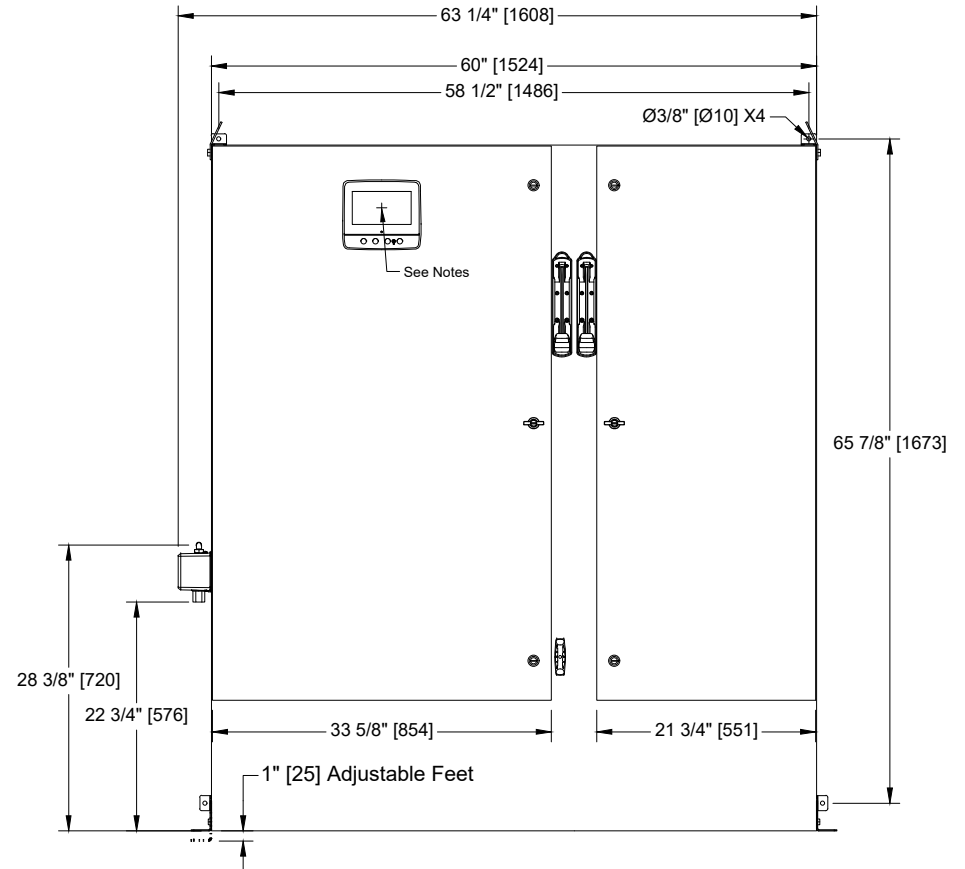



© Firetrol, Inc. Not for construction.
Subject to change without notice.

| | |
|----------------|--------------|
| BY | DD/MM/YY |
| DRAWN BY | ACD 28/02/23 |
| FINAL APPROVAL | FC 28/02/23 |

ELECTRIC FIRE PUMP CONTROLLER REDUCED VOLTAGE / WYE-DELTA (CLOSED TRANSITION) WITH AUTOMATIC TRANSFER SWITCH

MODEL:FTA1350

BUILT TO THE LATEST EDITION OF THE NFPA20 & NFPA70



| | |
|----------------|--------------|
| DRAWING NUMBER | WS1350-810/E |
| DWG REV. 0 | |
| SHEET 1 OF 2 | |

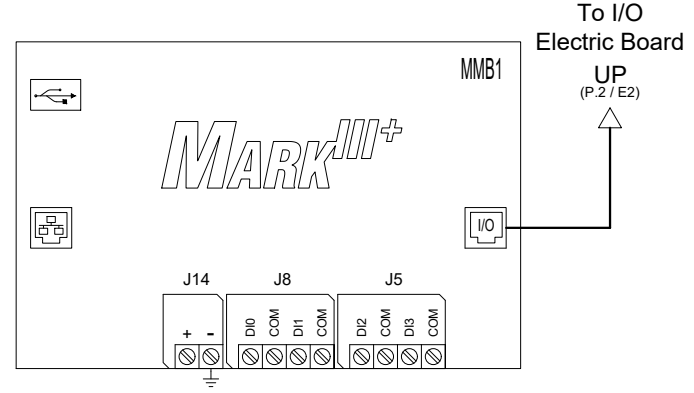
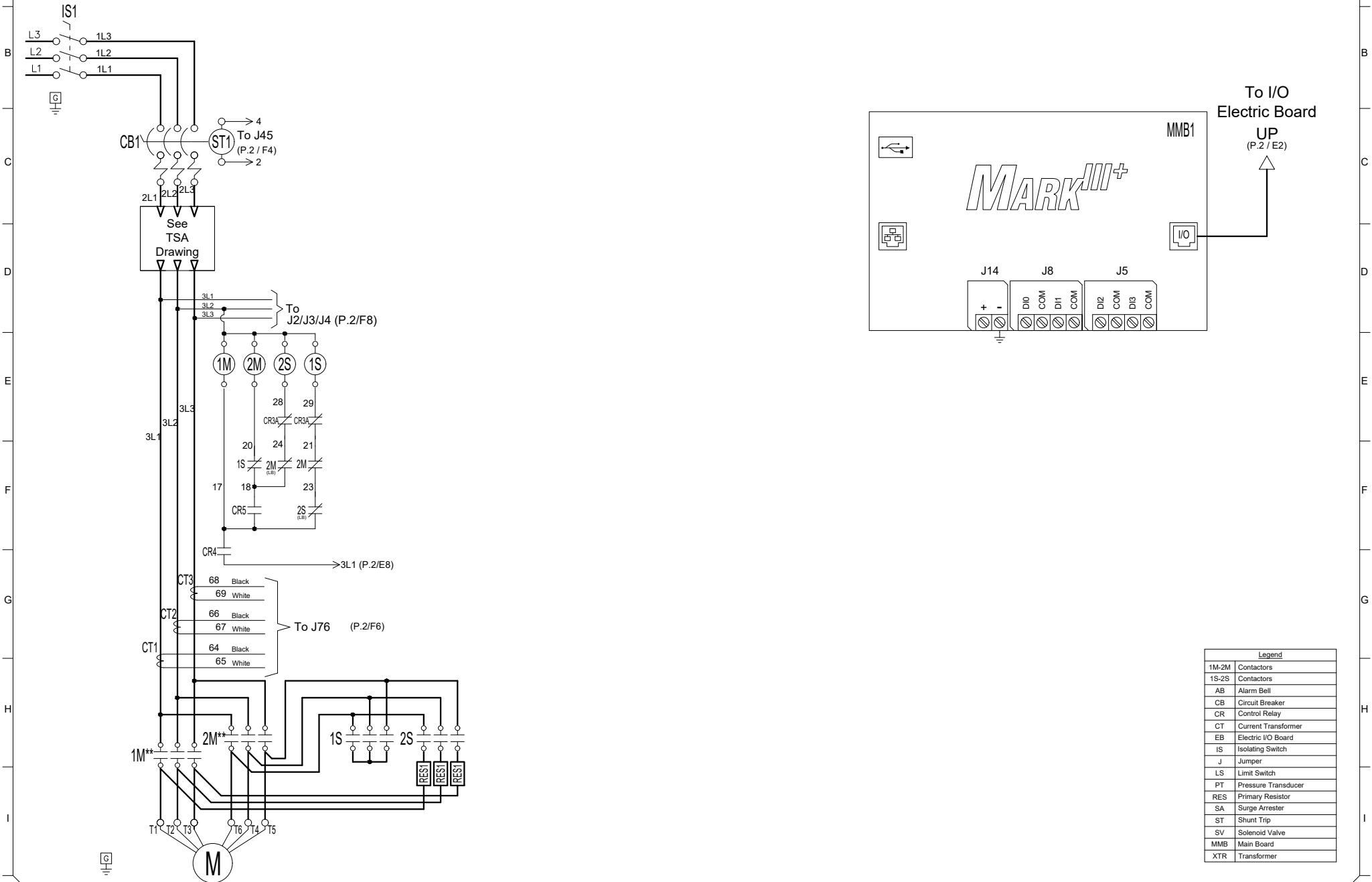

| Legend | |
|--------|---------------------|
| 1M-2M | Contactors |
| 1S-2S | Contactors |
| AB | Alarm Bell |
| CB | Circuit Breaker |
| CR | Control Relay |
| CT | Current Transformer |
| EB | Electric I/O Board |
| IS | Isolating Switch |
| J | Jumper |
| LS | Limit Switch |
| PT | Pressure Transducer |
| RES | Primary Resistor |
| SA | Surge Arrester |
| ST | Shunt Trip |
| SV | Solenoid Valve |
| MMB | Main Board |
| XTR | Transformer |



© Firetrol, Inc. Not for construction.
Subject to change without notice.

| | | | |
|----------------|-----|----------|--|
| BY | | DD/MM/YY | |
| DRAWN BY | ACD | 28/02/23 | |
| FINAL APPROVAL | FC | 28/02/23 | |

ELECTRIC FIRE PUMP CONTROLLER REDUCED VOLTAGE / WYE-DELTA (CLOSED TRANSITION) WITH AUTOMATIC TRANSFER SWITCH

MODEL: FTA1350

BUILT TO THE LATEST EDITION OF THE NFPA20 & NFPA70



| | |
|----------------|--------------|
| DRAWING NUMBER | WS1350-810/E |
| DWG REV. 0 | |
| SHEET 2 OF 2 | |

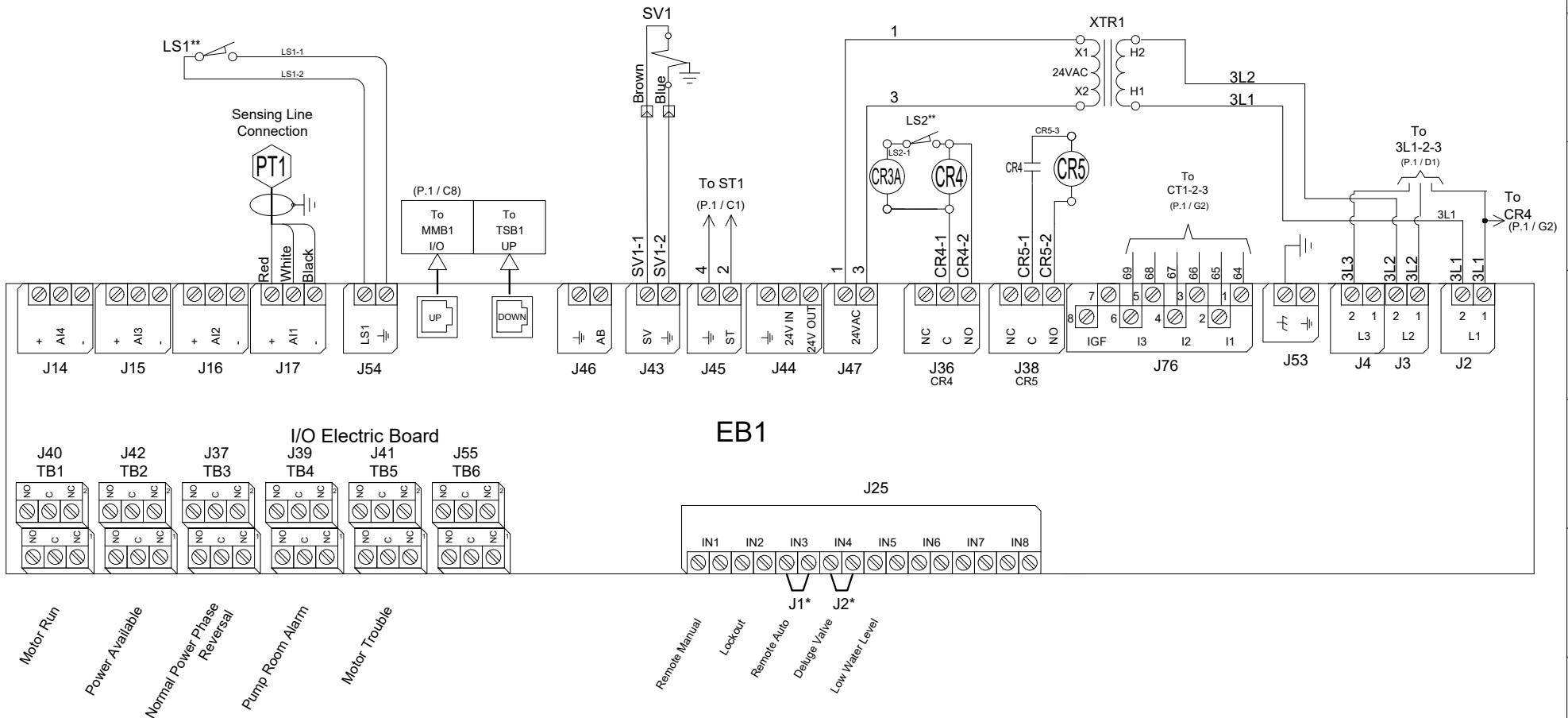

* Remove jumper to use this feature
** Contact closes when emergency start is in "ON" position



© Firetrol, Inc. Not for construction.
Subject to change without notice.

| | |
|----------------|--------------|
| BY | DD/MM/YY |
| DRAWN BY | ACD 28/02/23 |
| FINAL APPROVAL | FC 28/02/23 |

AUTOMATIC TRANSFER SWITCH FOR ELECTRIC FIRE PUMP CONTROLLER

MODEL: FTA950

BUILT TO THE LATEST EDITION OF THE NFPA20 & NFPA70



| | |
|----------------|--------------|
| DRAWING NUMBER | WS950-800 /E |
| DWG REV. 0 | |
| SHEET 1 OF 1 | |

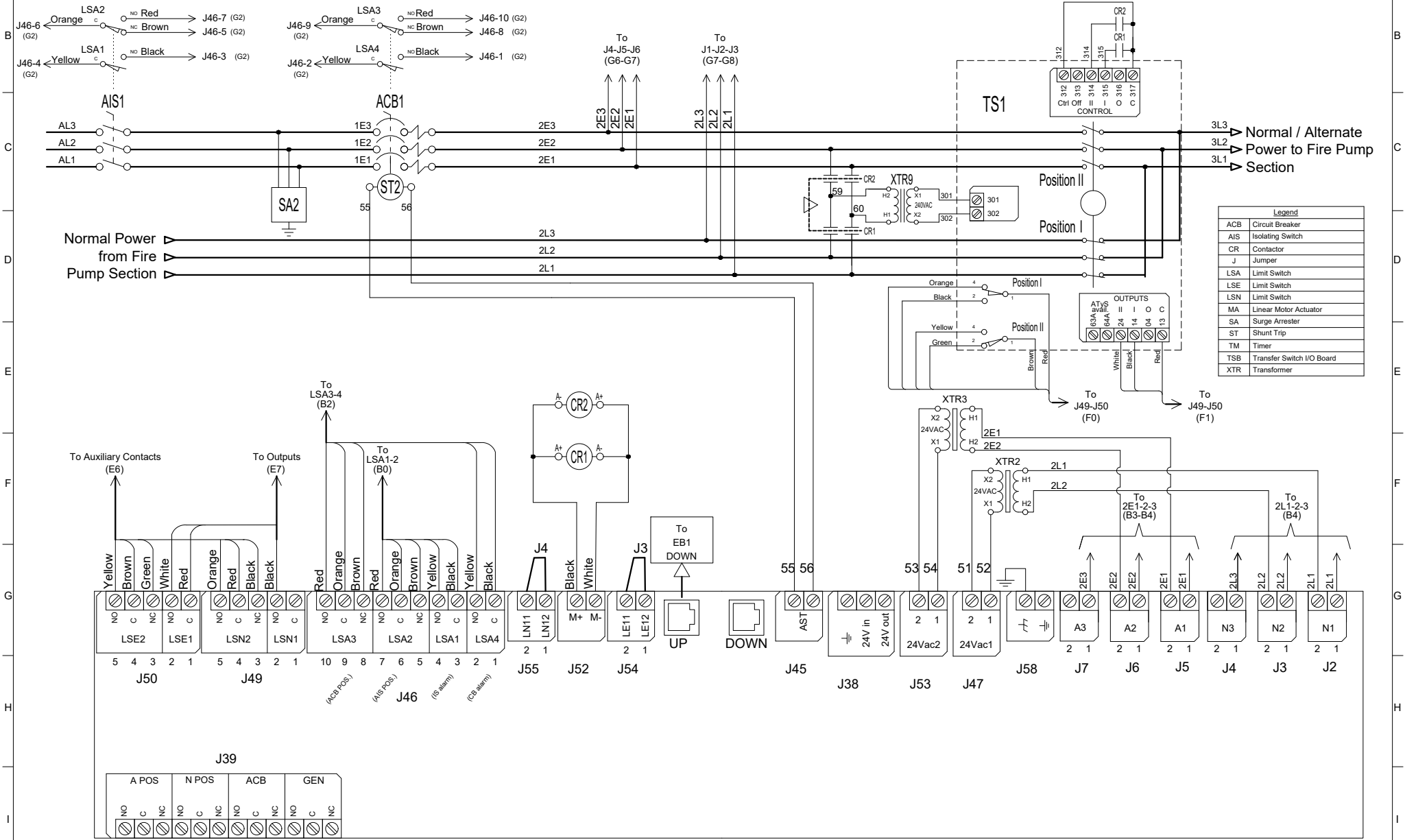

| Legend | |
|--------|---------------------------|
| ACB | Circuit Breaker |
| AIS | Isolating Switch |
| CR | Contactors |
| J | Jumper |
| LSA | Limit Switch |
| LSE | Limit Switch |
| LSN | Limit Switch |
| MA | Linear Motor Actuator |
| SA | Surge Arrester |
| ST | Shunt Trip |
| TM | Timer |
| TSB | Transfer Switch I/O Board |
| XTR | Transformer |



© Firetrol, Inc. Not for construction.
Subject to change without notice.

| | |
|----------------|--------------|
| BY DD/MM/YY | |
| DRAWN BY | ACD 28/02/23 |
| FINAL APPROVAL | FC 28/02/23 |

ELECTRIC FIRE PUMP CONTROLLER

MODEL: FTA1000

BUILT TO THE LATEST EDITION OF THE NFPA20 & NFPA70



| | |
|----------------|---------------|
| DRAWING NUMBER | FC1000-800 /E |
| DWG REV. 0 | |
| SHEET 1 OF 1 | |

COPPER CONDUCTORS for Isolating Switch (IS1).

Field Wiring According to Bending Space (AWG or MCM). Terminals L1 - L2 - L3

| Bending Space | 5" (127 mm) | | | | | | | 8" (203 mm) | | |
|---------------|----------------|----------------|----------------|----------------|----------------|---------------|---------------|---------------|-----------------|-----------------|
| | HP Voltage | 5 | 7.5 | 10 | 15 | 20 | 25 | 30 | 40 | 50 |
| 208 | 1x (10 to 1/0) | 1x (8 to 1/0) | 1x (8 to 1/0) | 1x (6 to 1/0) | 1x (4 to 1/0) | 1x (3 to 1/0) | 1x (2 to 1/0) | 1x (1 to 3/0) | 1x (3/0 to 250) | 1x (4/0 to 250) |
| 220 to 240 | 1x (10 to 1/0) | 1x (10 to 1/0) | 1x (8 to 1/0) | 1x (6 to 1/0) | 1x (4 to 1/0) | 1x (4 to 1/0) | 1x (3 to 1/0) | 1x (1 to 3/0) | 1x (2/0 to 3/0) | 1x (3/0 to 250) |
| 380 to 416 | 1x (10 to 1/0) | 1x (10 to 1/0) | 1x (10 to 1/0) | 1x (8 to 1/0) | 1x (8 to 1/0) | 1x (6 to 1/0) | 1x (6 to 1/0) | 1x (4 to 1/0) | 1x (3 to 1/0) | 1x (3 to 1/0) |
| 440 to 480 | 1x (10 to 1/0) | 1x (10 to 1/0) | 1x (10 to 1/0) | 1x (10 to 1/0) | 1x (8 to 1/0) | 1x (8 to 1/0) | 1x (6 to 1/0) | 1x (6 to 1/0) | 1x (4 to 1/0) | 1x (3 to 1/0) |
| 600 | 1x (10 to 1/0) | 1x (10 to 1/0) | 1x (10 to 1/0) | 1x (10 to 1/0) | 1x (10 to 1/0) | 1x (8 to 1/0) | 1x (8 to 1/0) | 1x (6 to 1/0) | 1x (6 to 1/0) | 1x (4 to 1/0) |

Power Terminals

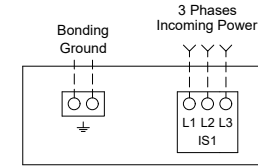

| Bending Space | 12" (305 mm) | | | | 16" (406 mm) | | | | | | | |
|---------------|-----------------|-----------------|-----------------|-----------------|-----------------|-----------------|-----------------|-----------------|-----------------|-----------------|-----------------|-------|
| | HP Voltage | 75 | 100 | 125 | 150 | 200 | 250 | 300 | 350 | 400 | 450 | 500 |
| 208 | 2x (1/0 to 500) | 2x (2/0 to 500) | 2x (4/0 to 500) | 2x (250 to 500) | 3x (4/0 to 500) | ----- | ----- | ----- | ----- | ----- | ----- | ----- |
| 220 to 240 | 1x (250) | 2x (2/0 to 500) | 2x (3/0 to 500) | 2x (4/0 to 500) | 2x (350 to 500) | 3x (250 to 500) | ----- | ----- | ----- | ----- | ----- | ----- |
| 380 to 416 | 1x (1/0 to 3/0) | 1x (3/0 to 250) | 1x (250) | 2x (1/0 to 500) | 2x (3/0 to 500) | 2x (4/0 to 500) | 2x (300 to 500) | 2x (400 to 500) | 3x (250 to 500) | 3x (300 to 500) | ----- | ----- |
| 440 to 480 | 1x (1 to 3/0) | 1x (2/0 to 3/0) | 1x (3/0 to 250) | 1x (4/0 to 250) | 2x (1/0 to 500) | 2x (3/0 to 500) | 2x (4/0 to 500) | 2x (300 to 500) | 2x (350 to 500) | 2x (400 to 500) | 3x (250 to 500) | ----- |
| 600 | 1x (3 to 1/0) | 1x (1 to 3/0) | 1x (2/0 to 3/0) | 1x (3/0 to 250) | 1x (250) | 2x (2/0 to 500) | 2x (3/0 to 500) | 2x (4/0 to 500) | 2x (250 to 500) | 2x (300 to 500) | 2x (350 to 500) | ----- |
| Bending Space | 5" (127 mm) | 8" (203 mm) | | | | 12" (305 mm) | | | | | | |

ALUMINUM CONDUCTORS for Isolating Switch (IS1).

Field Wiring According to Bending Space (AWG or MCM). Terminals L1 - L2 - L3

| Bending Space | 5" (127 mm) | | | | | | | 8" (203 mm) | | 10" (254 mm) |
|---------------|----------------|----------------|----------------|----------------|---------------|---------------|---------------|-----------------|-----------------|------------------------------|
| | HP Voltage | 5 | 7.5 | 10 | 15 | 20 | 25 | 30 | 40 | 50 |
| 208 | 1x (10 to 1/0) | 1x (6 to 1/0) | 1x (6 to 1/0) | 1x (4 to 1/0) | 1x (3 to 1/0) | 1x (2 to 1/0) | 1x (1/0) | 1x (3/0) | 1x (4/0 to 250) | 1x (300)** or 1x (250) 90°C* |
| 220 to 240 | 1x (10 to 1/0) | 1x (8 to 1/0) | 1x (6 to 1/0) | 1x (4 to 1/0) | 1x (3 to 1/0) | 1x (2 to 1/0) | 1x (1 to 1/0) | 1x (2/0 to 3/0) | 1x (3/0) 90°C* | 1x (250) |
| 380 to 416 | 1x (10 to 1/0) | 1x (10 to 1/0) | 1x (10 to 1/0) | 1x (6 to 1/0) | 1x (6 to 1/0) | 1x (4 to 1/0) | 1x (4 to 1/0) | 1x (2 to 1/0) | 1x (1 to 1/0) | 1x (1/0) |
| 440 to 480 | 1x (10 to 1/0) | 1x (10 to 1/0) | 1x (10 to 1/0) | 1x (8 to 1/0) | 1x (6 to 1/0) | 1x (6 to 1/0) | 1x (6 to 1/0) | 1x (4 to 1/0) | 1x (2 to 1/0) | 1x (1 to 1/0) |
| 600 | 1x (10 to 1/0) | 1x (10 to 1/0) | 1x (10 to 1/0) | 1x (10 to 1/0) | 1x (8 to 1/0) | 1x (6 to 1/0) | 1x (6 to 1/0) | 1x (4 to 1/0) | 1x (4 to 1/0) | 1x (2 to 1/0) |

| Bending Space | 12" (305 mm) | | | | 16" (406 mm) | | | | | | | |
|---------------|-----------------|-----------------|-----------------|-------------------|-----------------|-----------------|-----------------|-------------------|-----------------|-----------------|-----------------|-------|
| | HP Voltage | 75 | 100 | 125 | 150 | 200 | 250 | 300 | 350 | 400 | 450 | 500 |
| 208 | 2x (2/0 to 500) | 2x (4/0 to 500) | 2x (300 to 500) | 2x (350 to 500) | 3x (300 to 500) | ----- | ----- | ----- | ----- | ----- | ----- | ----- |
| 220 to 240 | 1x (350)** | 2x (3/0 to 500) | 2x (250 to 500) | 2x (300 to 500) | 2x (500) | 3x (400 to 500) | ----- | ----- | ----- | ----- | ----- | ----- |
| 380 to 416 | N/A | 1x (250 to 350) | 1x (350)** | 2x (3/0 to 500) | 2x (4/0 to 500) | 2x (300 to 500) | 2x (500) | 3x (300 to 500)** | 3x (350 to 500) | 3x (400 to 500) | ----- | ----- |
| 440 to 480 | 1x (1/0 to 3/0) | 1x (3/0) | N/A | 1x (300 to 350)** | 2x (3/0 to 500) | 2x (250 to 500) | 2x (300 to 500) | 2x (400 to 500) | 2x (500) | 2x (500) 90°C* | 3x (350 to 500) | ----- |
| 600 | 1x (1 to 1/0) | 1x (2/0 to 3/0) | 1x (3/0) 90°C* | 1x (4/0 to 250) | 1x (350 to 500) | 2x (3/0 to 500) | 2x (4/0 to 250) | 2x (300 to 500) | 2x (350 to 500) | 2x (400 to 500) | 2x (500) | ----- |
| Bending Space | 5" (127 mm) | 8" (203 mm) | | | | 12" (305 mm) | | | | | | |

Notes:

- 1 - For proper wire sizing, refer to NFPA70 and NEC (USA) or CEC (Canada) or local code.
- 2 - Controller suitable for service entrance in USA.
- 3 - For more accurate motor connections refer to motor manufacturer or motor nameplate.
- 4 - Controller is phase sensitive. Incoming lines must be connected in ABC sequence.

Drawing for information only.
Manufacturer reserves the right to modify this drawing without notice.
Contact manufacturer for "As Built" drawing.

*For standard enclosure, use 90°C aluminium wire. Consult Factory for Use of Conductors Rated Lower than 90°C.

** Consult Factory



© Firetrol, Inc. Not for construction.
Subject to change without notice.

| | |
|----------------|--------------|
| BY DD/MM/YY | |
| DRAWN BY | ACD 28/02/23 |
| FINAL APPROVAL | FC 28/02/23 |

AUTOMATIC TRANSFER SWITCH FOR ELECTRIC FIRE PUMP CONTROLLER

MODEL: FTA950

BUILT TO THE LATEST EDITION OF THE NFPA20 & NFPA70



| | |
|----------------|--------------|
| DRAWING NUMBER | FC950-800 /E |
| DWG REV. 0 | |
| SHEET 1 OF 1 | |

COPPER CONDUCTORS for Isolating Switch (AIS1).

Field Wiring According to Bending Space (AWG or MCM). Terminals AL1 - AL2 - AL3

| Bending Space | 5" (127 mm) | | | | | | | 8" (203 mm) | | |
|---------------|----------------|----------------|----------------|----------------|----------------|---------------|---------------|-----------------|-----------------|-----------------|
| | HP Voltage | 5 | 7.5 | 10 | 15 | 20 | 25 | 30 | 40 | 50 |
| 208 | 1x (10 to 1/0) | 1x (8 to 1/0) | 1x (8 to 1/0) | 1x (6 to 1/0) | 1x (4 to 1/0) | 1x (3 to 1/0) | 1x (2 to 1/0) | 1x (1/0 to 3/0) | 1x (3/0 to 250) | 1x (4/0 to 250) |
| 220 to 240 | 1x (10 to 1/0) | 1x (10 to 1/0) | 1x (8 to 1/0) | 1x (6 to 1/0) | 1x (4 to 1/0) | 1x (4 to 1/0) | 1x (3 to 1/0) | 1x (1 to 3/0) | 1x (2/0 to 3/0) | 1x (3/0 to 250) |
| 380 to 416 | 1x (10 to 1/0) | 1x (10 to 1/0) | 1x (10 to 1/0) | 1x (8 to 1/0) | 1x (8 to 1/0) | 1x (6 to 1/0) | 1x (6 to 1/0) | 1x (4 to 1/0) | 1x (3 to 1/0) | 1x (3 to 1/0) |
| 440 to 480 | 1x (10 to 1/0) | 1x (10 to 1/0) | 1x (10 to 1/0) | 1x (10 to 1/0) | 1x (8 to 1/0) | 1x (8 to 1/0) | 1x (6 to 1/0) | 1x (6 to 1/0) | 1x (4 to 1/0) | 1x (3 to 1/0) |
| 600 | 1x (10 to 1/0) | 1x (10 to 1/0) | 1x (10 to 1/0) | 1x (10 to 1/0) | 1x (10 to 1/0) | 1x (8 to 1/0) | 1x (8 to 1/0) | 1x (6 to 1/0) | 1x (6 to 1/0) | 1x (4 to 1/0) |

Power Terminals

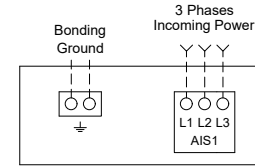

| Bending Space | 12" (305 mm) | | | | 16" (406 mm) | | | | | | | |
|---------------|-----------------|-----------------|-----------------|-----------------|-----------------|-----------------|-----------------|-----------------|-----------------|-----------------|-----------------|-------|
| | HP Voltage | 75 | 100 | 125 | 150 | 200 | 250 | 300 | 350 | 400 | 450 | 500 |
| 208 | 2x (1/0 to 500) | 2x (2/0 to 500) | 2x (4/0 to 500) | 2x (250 to 500) | 3x (4/0 to 500) | ----- | ----- | ----- | ----- | ----- | ----- | ----- |
| 220 to 240 | 1x (250) | 2x (2/0 to 500) | 2x (3/0 to 500) | 2x (4/0 to 500) | 2x (350 to 500) | 3x (250 to 500) | ----- | ----- | ----- | ----- | ----- | ----- |
| 380 to 416 | 1x (1/0 to 3/0) | 1x (3/0 to 250) | 1x (250) | 2x (1/0 to 500) | 2x (3/0 to 500) | 2x (4/0 to 500) | 2x (300 to 500) | 2x (400 to 500) | 3x (250 to 500) | 3x (300 to 500) | ----- | ----- |
| 440 to 480 | 1x (1 to 3/0) | 1x (2/0 to 3/0) | 1x (3/0 to 250) | 1x (4/0 to 250) | 2x (1/0 to 500) | 2x (3/0 to 500) | 2x (4/0 to 500) | 2x (300 to 500) | 2x (350 to 500) | 2x (400 to 500) | 3x (250 to 500) | ----- |
| 600 | 1x (3 to 1/0) | 1x (1 to 3/0) | 1x (2/0 to 3/0) | 1x (3/0 to 250) | 1x (250) | 2x (2/0 to 500) | 2x (3/0 to 500) | 2x (4/0 to 500) | 2x (250 to 500) | 2x (300 to 500) | 2x (350 to 500) | ----- |
| Bending Space | 5" (127 mm) | 8" (203 mm) | | | | 12" (305 mm) | | | | | | |

ALUMINUM CONDUCTORS for Isolating Switch (AIS1).

Field Wiring According to Bending Space (AWG or MCM). Terminals AL1 - AL2 - AL3

| Bending Space | 5" (127 mm) | | | | | | | 8" (203 mm) | | 10" (254 mm) |
|---------------|----------------|----------------|----------------|----------------|---------------|---------------|---------------|-----------------|-----------------|------------------------------|
| | HP Voltage | 5 | 7.5 | 10 | 15 | 20 | 25 | 30 | 40 | 50 |
| 208 | 1x (10 to 1/0) | 1x (6 to 1/0) | 1x (6 to 1/0) | 1x (4 to 1/0) | 1x (3 to 1/0) | 1x (1 to 1/0) | 1x (1/0) | 1x (3/0) | 1x (4/0 to 250) | 1x (300)** or 1x (250) 90°C* |
| 220 to 240 | 1x (10 to 1/0) | 1x (8 to 1/0) | 1x (6 to 1/0) | 1x (4 to 1/0) | 1x (3 to 1/0) | 1x (2 to 1/0) | 1x (1 to 1/0) | 1x (2/0 to 3/0) | 1x (3/0) 90°C* | 1x (250) |
| 380 to 416 | 1x (10 to 1/0) | 1x (10 to 1/0) | 1x (10 to 1/0) | 1x (6 to 1/0) | 1x (6 to 1/0) | 1x (4 to 1/0) | 1x (4 to 1/0) | 1x (2 to 1/0) | 1x (1 to 1/0) | 1x (1/0) |
| 440 to 480 | 1x (10 to 1/0) | 1x (10 to 1/0) | 1x (10 to 1/0) | 1x (8 to 1/0) | 1x (6 to 1/0) | 1x (6 to 1/0) | 1x (6 to 1/0) | 1x (4 to 1/0) | 1x (2 to 1/0) | 1x (1 to 1/0) |
| 600 | 1x (10 to 1/0) | 1x (10 to 1/0) | 1x (10 to 1/0) | 1x (10 to 1/0) | 1x (8 to 1/0) | 1x (6 to 1/0) | 1x (6 to 1/0) | 1x (4 to 1/0) | 1x (4 to 1/0) | 1x (2 to 1/0) |

| Bending Space | 12" (305 mm) | | | | 16" (406 mm) | | | | | | | |
|---------------|-----------------|-----------------|-----------------|-------------------|-----------------|-----------------|-----------------|-------------------|-----------------|-----------------|-----------------|-------|
| | HP Voltage | 75 | 100 | 125 | 150 | 200 | 250 | 300 | 350 | 400 | 450 | 500 |
| 208 | 2x (2/0 to 500) | 2x (4/0 to 500) | 2x (300 to 500) | 2x (350 to 500) | 3x (300 to 500) | ----- | ----- | ----- | ----- | ----- | ----- | ----- |
| 220 to 240 | 1x (350)** | 2x (3/0 to 500) | 2x (250 to 500) | 2x (300 to 500) | 2x (500) | 3x (400 to 500) | ----- | ----- | ----- | ----- | ----- | ----- |
| 380 to 416 | N/A | 1x (250 to 350) | 1x (350)** | 2x (3/0 to 500) | 2x (4/0 to 500) | 2x (300 to 500) | 2x (500) | 3x (300 to 500)** | 3x (350 to 500) | 3x (400 to 500) | ----- | ----- |
| 440 to 480 | 1x (1/0 to 3/0) | 1x (3/0) | N/A | 1x (300 to 350)** | 2x (3/0 to 500) | 2x (250 to 500) | 2x (300 to 500) | 2x (400 to 500) | 2x (500) | 2x (500) 90°C* | 3x (350 to 500) | ----- |
| 600 | 1x (1 to 1/0) | 1x (2/0 to 3/0) | 1x (3/0) 90°C* | 1x (4/0 to 250) | 1x (350 to 500) | 2x (3/0 to 500) | 2x (4/0 to 250) | 2x (300 to 500) | 2x (350 to 500) | 2x (400 to 500) | 2x (500) | ----- |
| Bending Space | 5" (127 mm) | 8" (203 mm) | | | | 12" (305 mm) | | | | | | |

Notes:
1 - Controller is phase sensitive. Incoming lines must be connected in ABC sequence.

Drawing for information only.
Manufacturer reserves the right to modify this drawing without notice.
Contact manufacturer for "As Built" drawing.

*For standard enclosure, use 90°C aluminium wire. Consult Factory for Use of Conductors Rated Lower than 90°C.

** Consult Factory



© Firetrol, Inc. Not for construction.
Subject to change without notice.

| | |
|----------------|--------------|
| BY DD/MM/YY | |
| DRAWN BY | ACD 28/02/23 |
| FINAL APPROVAL | FC 28/02/23 |

ELECTRIC FIRE PUMP CONTROLLER

MODEL: FTA1250/FTA1300/FTA1350

BUILT TO THE LATEST EDITION OF THE NFPA20 & NFPA70



| | |
|----------------|---------------|
| DRAWING NUMBER | FC1000-802 /E |
| DWG REV. 0 | |
| SHEET 1 OF 1 | |

COPPER CONDUCTORS for Motor Connection (1M-2M).

Field Wiring According to Bending Space (AWG or MCM). Terminals T1-T2-T3-T4-T5-T6-T7-T8-T9

| HP Voltage | 5 | 7.5 | 10 | 15 | 20 | 25 | 30 | 40 | 50 | 60 |
|---------------|--------------|--------------|--------------|--------------|--------------|--------------|--------------|---------------|---------------|---------------|
| 208 | 1x (10 to 4) | 1x (10 to 4) | 1x (10 to 4) | 1x (8 to 4) | 1x (8 to 4) | 1x (6 to 4) | 1x (6 to 4) | 1x (4 to 2/0) | 1x (2 to 2/0) | 1x (1 to 2/0) |
| 220 to 240 | 1x (10 to 4) | 1x (10 to 4) | 1x (10 to 4) | 1x (8 to 4) | 1x (8 to 4) | 1x (6 to 4) | 1x (6 to 4) | 1x (4) | 1x (3 to 2/0) | 1x (2 to 2/0) |
| 380 to 416 | 1x (10 to 4) | 1x (10 to 4) | 1x (10 to 4) | 1x (10 to 4) | 1x (10 to 4) | 1x (10 to 4) | 1x (8 to 4) | 1x (8 to 4) | 1x (6 to 4) | 1x (4) |
| 440 to 480 | 1x (10 to 4) | 1x (10 to 4) | 1x (10 to 4) | 1x (10 to 4) | 1x (10 to 4) | 1x (10 to 4) | 1x (10 to 4) | 1x (8 to 4) | 1x (8 to 4) | 1x (6 to 4) |
| 600 | 1x (10 to 4) | 1x (10 to 4) | 1x (10 to 4) | 1x (10 to 4) | 1x (10 to 4) | 1x (10 to 4) | 1x (10 to 4) | 1x (10 to 4) | 1x (8 to 4) | 1x (8 to 4) |

| HP Voltage | 75 | 100 | 125 | 150 | 200 | 250 | 300 | 350 | 400 | 450 | 500 |
|---------------|-----------------|-----------------|-----------------|-----------------|-----------------|-----------------|-----------------|-----------------|-----------------|-----------------|-----------------|
| 208 | 1x (2/0 to 3/0) | 1x (3/0 to 300) | 1x (250 to 300) | 2x (1/0 to 300) | 2x (3/0 to 350) | ----- | ----- | ----- | ----- | ----- | ----- |
| 220 to 240 | 1x (1/0 to 2/0) | 1x (3/0) | 1x (4/0 to 300) | 1x (300) | 2x (2/0 to 300) | 2x (4/0 to 350) | ----- | ----- | ----- | ----- | ----- |
| 380 to 416 | 1x (4 to 2/0) | 1x (2 to 2/0) | 1x (1/0 to 2/0) | 1x (2/0 to 3/0) | 1x (4/0 to 300) | 1x (300) | 2x (2/0 to 300) | 2x (3/0 to 300) | 2x (4/0 to 350) | 2x (4/0 to 350) | ----- |
| 440 to 480 | 1x (4) | 1x (3 to 2/0) | 1x (2 to 2/0) | 1x (1/0 to 3/0) | 1x (2/0 to 3/0) | 1x (4/0 to 300) | 1x (300) | 2x (1/0 to 300) | 2x (2/0 to 300) | 2x (3/0 to 350) | 2x (4/0 to 350) |
| 600 | 1x (6 to 4) | 1x (4) | 1x (3 to 2/0) | 1x (2 to 2/0) | 1x (1/0 to 3/0) | 1x (2/0 to 3/0) | 1x (4/0 to 300) | 1x (250 to 300) | 1x (300) | 2x (1/0 to 300) | 2x (2/0 to 300) |

Motor Terminals

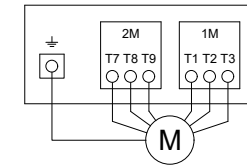

Model: FTA1250

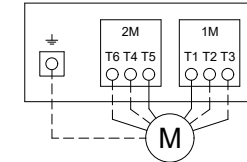

Models: FTA1300/FTA1350

ALUMINUM CONDUCTORS for Contactor (1M-2M).

Field Wiring According to Bending Space (AWG or MCM). Terminals T1-T2-T3-T4-T5-T6-T7-T8-T9

| HP Voltage | 5 | 7.5 | 10 | 15 | 20 | 25 | 30 | 40 | 50 | 60 |
|---------------|-------------------|-------------------|-------------------|-------------------|-------------------|-------------------|-------------------|------------------|------------------|------------------|
| 208 | 1x (12 to 2/0) ** | 1x (10 to 2/0) ** | 1x (10 to 2/0) ** | 1x (8 to 2/0) ** | 1x (6 to 2/0) ** | 1x (4 to 2/0) ** | 1x (4 to 2/0) ** | 1x (2 to 2/0) | 1x (1/0 to 2/0) | 1x (2/0) |
| 220 to 240 | 1x (12 to 2/0) ** | 1x (10 to 2/0) ** | 1x (10 to 2/0) ** | 1x (8 to 2/0) ** | 1x (8 to 2/0) ** | 1x (6 to 2/0) ** | 1x (4 to 2/0) ** | 1x (2 to 2/0) ** | 1x (1 to 2/0) | 1x (1/0 to 2/0) |
| 380 to 416 | 1x (12 to 2/0) ** | 1x (12 to 2/0) ** | 1x (12 to 2/0) ** | 1x (10 to 2/0) ** | 1x (10 to 2/0) ** | 1x (8 to 2/0) ** | 1x (8 to 2/0) ** | 1x (6 to 2/0) ** | 1x (4 to 2/0) ** | 1x (3 to 2/0) ** |
| 440 to 480 | 1x (12 to 2/0) ** | 1x (12 to 2/0) ** | 1x (12 to 2/0) ** | 1x (12 to 2/0) ** | 1x (10 to 2/0) ** | 1x (10 to 2/0) ** | 1x (8 to 2/0) ** | 1x (8 to 2/0) ** | 1x (6 to 2/0) ** | 1x (4 to 2/0) ** |
| 600 | 1x (12 to 2/0) ** | 1x (12 to 2/0) ** | 1x (12 to 2/0) ** | 1x (12 to 2/0) ** | 1x (10 to 2/0) ** | 1x (10 to 2/0) ** | 1x (10 to 2/0) ** | 1x (8 to 2/0) ** | 1x (8 to 2/0) ** | 1x (6 to 2/0) ** |

| HP Voltage | 75 | 100 | 125 | 150 | 200 | 250 | 300 | 350 | 400 | 450 | 500 |
|---------------|------------------|------------------|-----------------|-----------------|-----------------|-----------------|-----------------|-----------------|-----------------|-----------------|-----------------|
| 208 | 1x (3/0) | Consult Factory | 1x (300) 90°C * | 2x (3/0 to 300) | 2x (250 to 350) | ----- | ----- | ----- | ----- | ----- | ----- |
| 220 to 240 | 1x (2/0) 90°C * | Consult Factory | 1x (300) | 1x (300) 90°C * | 2x (4/0 to 300) | 2x (300 to 350) | ----- | ----- | ----- | ----- | ----- |
| 380 to 416 | 1x (2 to 2/0) | 1x (1/0 to 2/0) | 1x (1/0 to 2/0) | 1x (3/0) 90°C * | 1x (300) | 1x (300) 90°C * | 2x (4/0 to 300) | 2x (250 to 300) | 2x (300 to 350) | 2x (300 to 350) | ----- |
| 440 to 480 | 1x (3 to 2/0) ** | 1x (2 to 2/0) | 1x (2/0) 90°C * | 1x (2/0 to 3/0) | 1x (3/0) 90°C * | 1x (300) | 1x (300) 90°C * | 2x (3/0 to 300) | 2x (4/0 to 300) | 2x (250 to 350) | 2x (300 to 350) |
| 600 | 1x (4 to 2/0) ** | 1x (3 to 2/0) ** | 1x (2 to 2/0) | 1x (1/0 to 3/0) | 1x (3/0) | 1x (3/0) 90°C * | 1x (300) | 1x (300) 90°C * | Consult Factory | 2x (3/0 to 300) | 2x (4/0 to 300) |

*For standard enclosure, use 90°C aluminium wire. Consult Factory for Use of Conductors Rated Lower than 90°C.

**Option V659 required.

Notes:

- 1 - For proper wire sizing, refer to NFPA70 and NEC (USA) or CEC (Canada) or local code.
- 2 - Controller suitable for service entrance in USA.
- 3 - For more accurate motor connections refer to motor manufacturer or motor nameplate.
- 4 - Controller is phase sensitive. Incoming lines must be connected in ABC sequence.

Drawing for information only.
Manufacturer reserves the right to modify this drawing without notice.
Contact manufacturer for "As Built" drawing.



© Firetrol, Inc. Not for construction.
Subject to change without notice.

| | | |
|----------------|-----|----------|
| BY | | DD/MM/YY |
| DRAWN BY | ACD | 28/02/23 |
| FINAL APPROVAL | FC | 28/02/23 |

ELECTRIC FIRE PUMP CONTROLLER

MODEL: FTA1000

BUILT TO THE LATEST EDITION OF THE NFPA20 & NFPA70



| | |
|----------------|---------------|
| DRAWING NUMBER | FC1000-803 /E |
| DWG REV. 0 | |
| SHEET 1 OF 1 | |

Field Connections

Terminals Wire Size:
24 - 12 AWG
0.5 Nm

- Remote Manual
- Lockout
- Remote Auto
- Deluge Valve
- Low Water Level

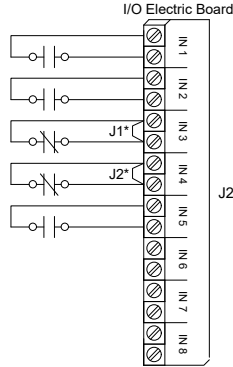

Network Connections

Terminals Wire Size:
Shielded Female Connector RJ45

Modbus TCP/IP RJ45

Located on Main Board



Alarm Contacts

Terminals Wire Size:
24 - 12 AWG
0.5 Nm

Controller Terminal Strip

- Motor Run
- Power Available
- Normal Power Phase Reversal
- Pump Room Alarm**
- Motor Trouble**
- (Field Programmable****)

I/O Electric Board

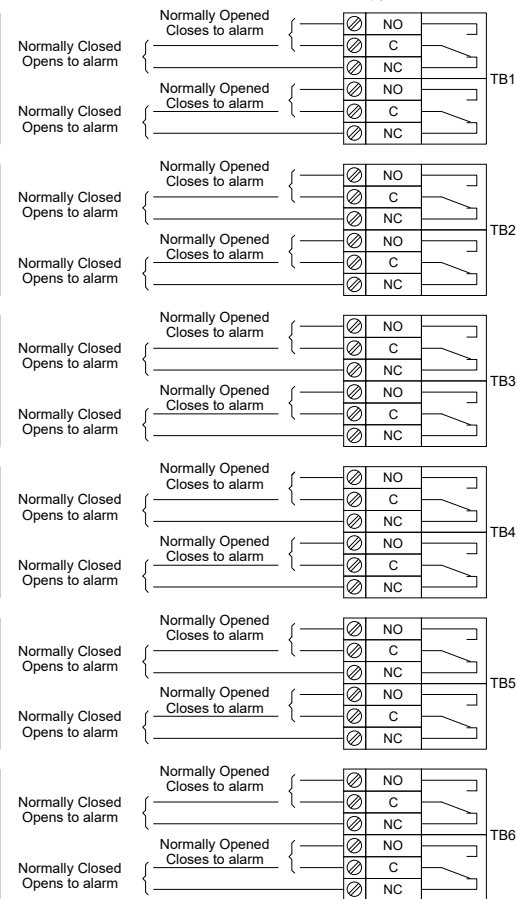

* Remove jumper to use this feature
 ** Re-assignable
 **** Not available on Model FTA1930



© Firetrol, Inc. Not for construction.
Subject to change without notice.

| | | |
|----------------|-----|----------|
| BY | | DD/MM/YY |
| DRAWN BY | ACD | 28/02/23 |
| FINAL APPROVAL | FC | 28/02/23 |

AUTOMATIC TRANSFER SWITCH FOR ELECTRIC FIRE PUMP CONTROLLER

MODEL: FTA950

BUILT TO THE LATEST EDITION OF THE NFPA20 & NFPA70



| | |
|----------------|--------------|
| DRAWING NUMBER | FC950-801 /E |
| DWG REV. | 0 |
| SHEET 1 OF 1 | |

Remote Alarm Terminals (TSB1)

Terminals Wire Size:
24 - 12 AWG
0.5 Nm

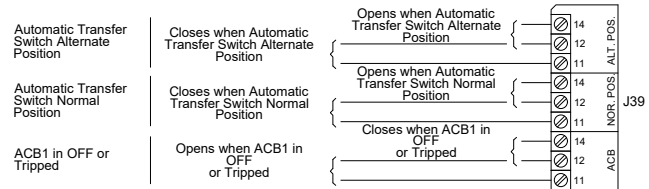

Control Terminals (TSB1)

Terminals Wire Size:
24 - 12 AWG
0.5 Nm

