

Jockey_{XG} Pump Controllers - Wye-Delta Open Transition Starting with C.B.

- MODIFICATION H - SPACE HEATER, 110-120VAC
- MODIFICATION L - SPACE HEATER, 220-240VAC

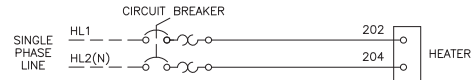

- MODIFICATION J - SPACE HEATER, 110-120VAC (WITH THERMOSTAT)
- MODIFICATION M - SPACE HEATER, 220-240VAC (WITH THERMOSTAT)

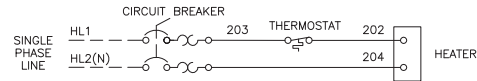

- MODIFICATION K - SPACE HEATER, 110-120VAC (WITH HUMIDISTAT)
- MODIFICATION N - SPACE HEATER, 220-240VAC (WITH HUMIDISTAT)

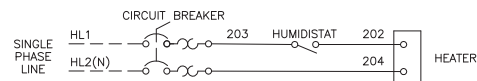

- MODIFICATION AC - PUMP OPERATING ALARM CONTACTS

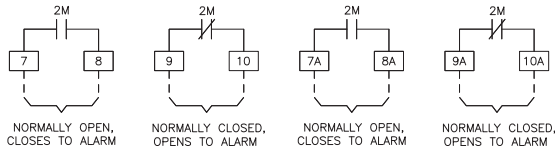

- MODIFICATION BY - PUMP OVERLOAD REMOTE ALARM CONTACT

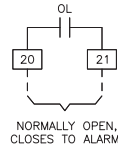

- MODIFICATION NZ - INTERLOCK SHUTDOWN IN AUTO

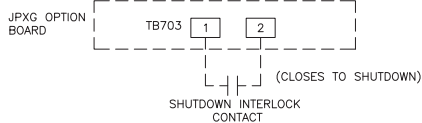

- MODIFICATION AST - REMOTE AUTO START INPUT

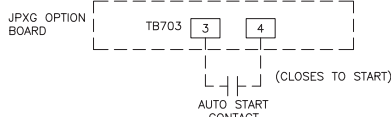

WIRING REQUIRED WHEN JPXG OPTION BOARD IS USED

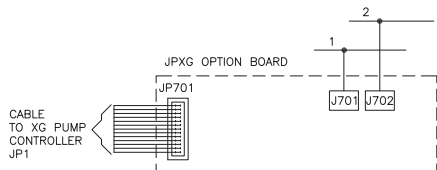

NOTE:
TERMINAL NUMBERS SUBJECT TO CHANGE

- MODIFICATION AM - PUMP FAILED TO START REMOTE ALARM CONTACTS

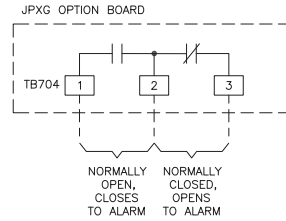

- MODIFICATION EF - SWITCH NOT IN AUTO REMOTE ALARM CONTACTS

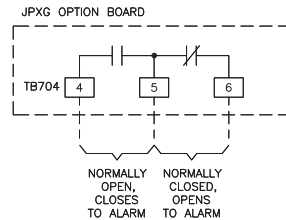

- MODIFICATION KH - COMMON TROUBLE REMOTE ALARM CONTACTS

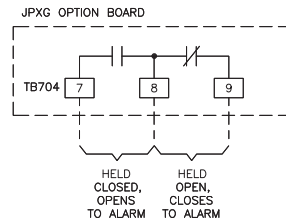

- MODIFICATION BW - PHASE FAILURE/REVERSAL REMOTE ALARM CONTACTS

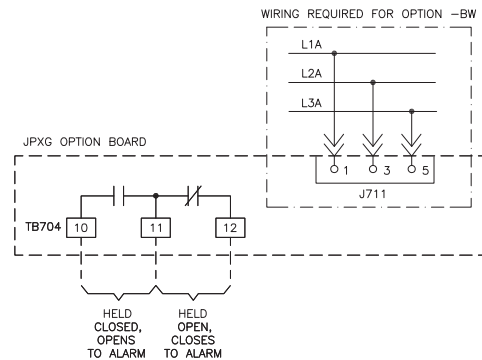

CONTROL AND ALARM TERMINAL WIRE CAPACITY	
JPXG OPTION BOARD TERMINALS	#18-12 AWG [0.75-4 MM ²]
PUMP OPERATING TERMINALS	#14-12 AWG [2.5-4 MM ²]
CIRCUIT BREAKERS	#14-4 AWG [2.5-25 MM ²]

	SIZE	A	BY	TEF	DATE	06-05-13	<p>© Firetrol, Inc. Not for construction. Subject to change without notice.</p>	UPDATED TITLE BLOCK	A	280596	JMW	TEF	08-28-19
	DRAWN BY	TEF	FINAL APPROVAL	TEF	06-05-13	REVISION DESCRIPTION		FTA556E	REV	ECN NO	BY	APP	DATE
	WIRING SCHEMATIC		FTA556E		DRAWING NUMBER			WS556-06					
	WYE-DELTA JOCKEY XG PUMP CONTROLLER OPTIONS AND MODIFICATIONS		DWG REV	A	ECN NO	280596		SHEET 1 OF 1					

All rights reserved. The drawing and the information contained or depicted herein are the sole property of Firetrol, Inc. Copies are communicated to the recipient in strict confidence and may not be retransmitted, published, reproduced, copied or used in any manner, including as the basis for the manufacture or sale of any products, without the express prior written consent of Firetrol, Inc.